

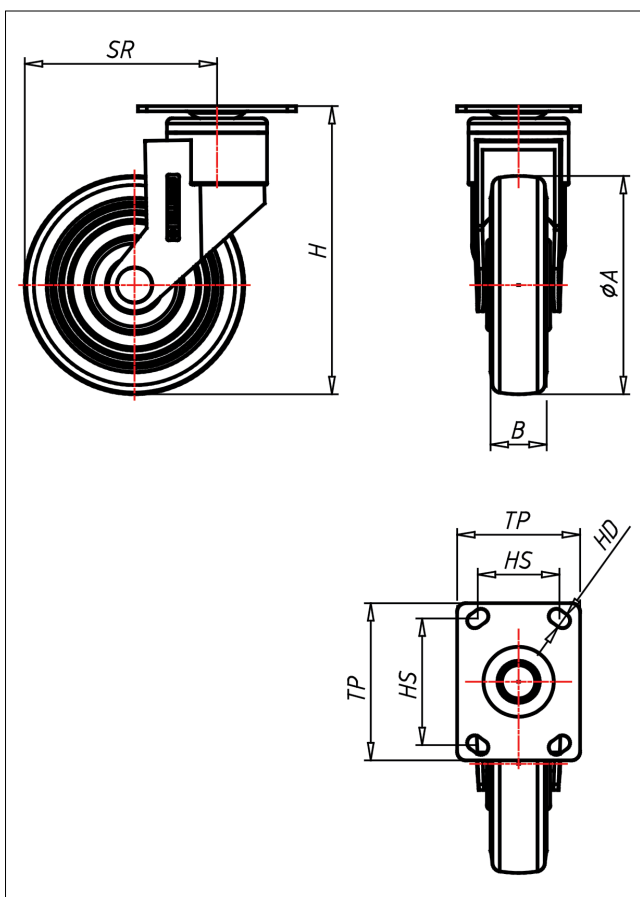

800 PT-AELK

Lenkrolle

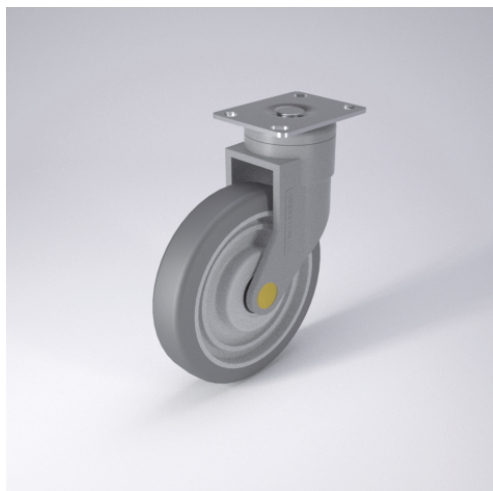

800P-AEL



LENKROLLE	LENKROLLE MIT TOTALFESTSTELLER	LENKROLLE MIT RICHTUNGSFESTSTELLER																				
<ul style="list-style-type: none"> • elektrisch leitfähig • geräuscharmer Lauf • geringer Rollwiderstand • spurfrei • hohe Stoßfestigkeit • sehr beständig gegen viele aggressive Medien 	<p>Polyamid 6-glasfaserverstärkt RAL 7005 Präzisionskugellager DIN 625 ZRS - doppelt gedichtet Radachse verschraubt → Seite 172</p>	<p>AUSWAHLHILFE:</p> <table border="1"> <tr> <td>leicht lenkend</td> <td>-</td> <td>+</td> <td>++</td> </tr> <tr> <td>verschleißarm</td> <td>X</td> <td></td> <td></td> </tr> <tr> <td>stoßfest</td> <td>X</td> <td></td> <td></td> </tr> <tr> <td>bodenschonend</td> <td></td> <td>X</td> <td></td> </tr> <tr> <td>witterungsbeständig</td> <td></td> <td>X</td> <td></td> </tr> </table>	leicht lenkend	-	+	++	verschleißarm	X			stoßfest	X			bodenschonend		X		witterungsbeständig		X	
leicht lenkend	-	+	++																			
verschleißarm	X																					
stoßfest	X																					
bodenschonend		X																				
witterungsbeständig		X																				
<p>Polyurethan Felge Polyamid 6</p>																						

Technische Details

ORDERNO (Artikel-nummer)	800 PT 200 AELK
WDAB (Rad-Ø A x Breite B / mm)	200x32
LC (Tragkraft / kg)	120
H (Bauhöhe H / mm)	251
TP (Plattengröße / mm)	90x70
HS (Lochabstand / mm)	70x50
HD (Loch-Ø / mm)	8.5
SR (Schwenkradius / mm)	167
WB (Radlager)	Kugellager