

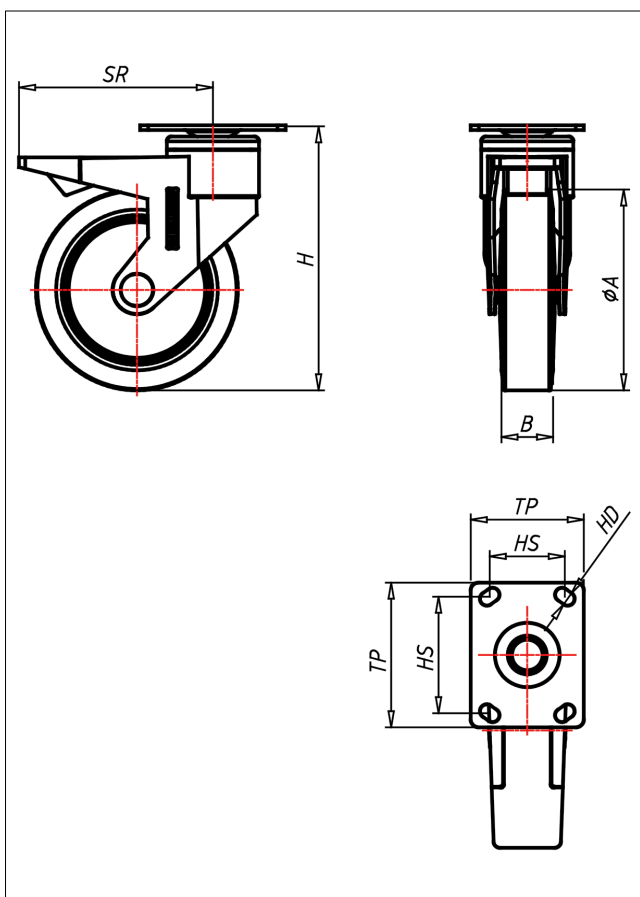

801 PT-GFK

Lenkrolle mit Totalfeststeller



800P-GF



LENKROLLE	LENKROLLE MIT TOTALFESTSTELLER	LENKROLLE MIT RICHTUNGSFESTSTELLER																		
<ul style="list-style-type: none"> • spurfrei • geräuscharmer Lauf • großer Fahrkomfort • beständig gegen verdünnte Säuren Vollgummi grau Felge Polypropylen	 Polyamid 6-glasfaserverstärkt RAL 7005 Präzisionskugellager DIN 625 2RS - doppelt gedichtet Radachse verschraubt → Seite 172	AUSWAHLHILFE: <table border="0"> <tr> <td>-</td><td>+</td><td>++</td></tr> <tr> <td>leicht lenkend</td><td>x</td><td>x</td></tr> <tr> <td>verschleißarm</td><td>x</td><td>x</td></tr> <tr> <td>stoßfest</td><td>x</td><td>x</td></tr> <tr> <td>bodenschonend</td><td>x</td><td>x</td></tr> <tr> <td>witterungsbeständig</td><td>x</td><td>x</td></tr> </table>	-	+	++	leicht lenkend	x	x	verschleißarm	x	x	stoßfest	x	x	bodenschonend	x	x	witterungsbeständig	x	x
-	+	++																		
leicht lenkend	x	x																		
verschleißarm	x	x																		
stoßfest	x	x																		
bodenschonend	x	x																		
witterungsbeständig	x	x																		

Technische Details

ORDERNO (Artikel-nummer)	801 PT 200 GFK
WDAB (Rad-Ø A x Breite B / mm)	200x32
LC (Tragkraft / kg)	120
H (Bauhöhe H / mm)	251
TP (Plattengröße / mm)	90x70
HS (Lochabstand / mm)	70x50
HD (Loch-Ø / mm)	8.5
SR (Schwenkradius / mm)	167
WB (Radlager)	Kugellager