

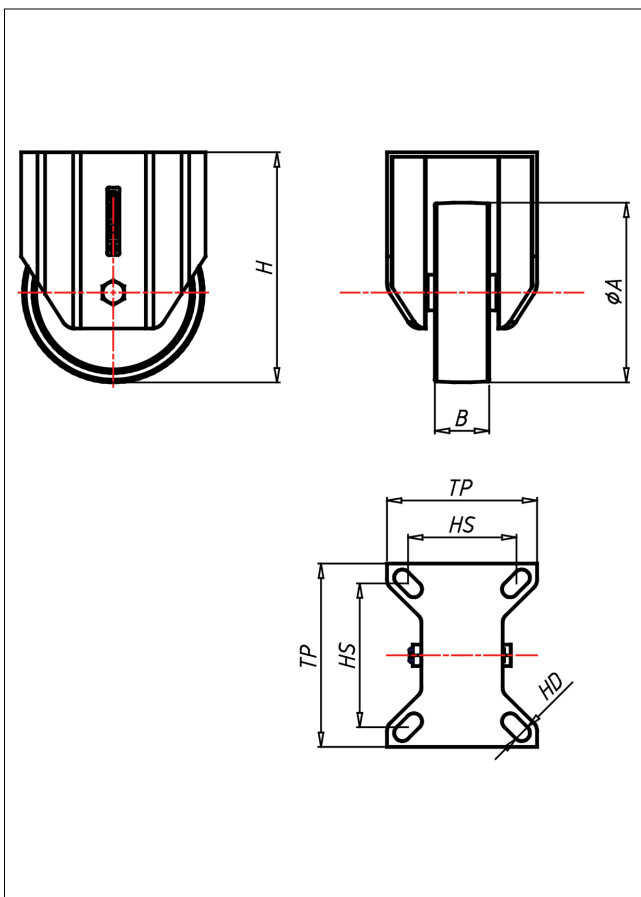

# CDF/CFS/CFSS-FS

## Bockrolle

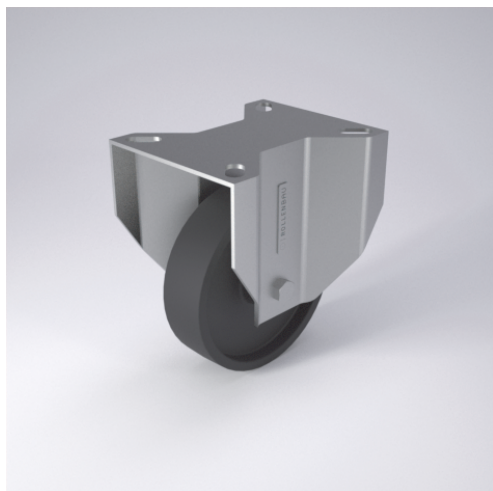

### CDH-FS



LENKROLLE																				
<ul style="list-style-type: none"> <li>• hitze- und kaltebeständig</li> <li>• leichter Lauf auf glatten Böden</li> <li>• stoß- und schlagfest</li> </ul> Monoblockrad schwarz → Seite 274	zweifaches Kugellager- vernietet Staubschutzring, verzinkt, Radachse verschraubt → Seite 160	AUSWAHLHILFE: <table border="1"> <tr><td>-</td><td>+</td><td>++</td></tr> <tr><td>leicht lenkend</td><td>x</td><td>x</td></tr> <tr><td>verschleißarm</td><td>x</td><td>x</td></tr> <tr><td>stoßfest</td><td>x</td><td>x</td></tr> <tr><td>bodenschonend</td><td>x</td><td>x</td></tr> <tr><td>witterungsbeständig</td><td>x</td><td>x</td></tr> </table>	-	+	++	leicht lenkend	x	x	verschleißarm	x	x	stoßfest	x	x	bodenschonend	x	x	witterungsbeständig	x	x
-	+	++																		
leicht lenkend	x	x																		
verschleißarm	x	x																		
stoßfest	x	x																		
bodenschonend	x	x																		
witterungsbeständig	x	x																		

### Technische Details

<b>ORDERNO (Artikel-nummer)</b>	CDF 80 FS
<b>WDAB (Rad-Ø A x Breite B / mm)</b>	80x30
<b>LC (Tragkraft / kg)</b>	150
<b>H (Bauhöhe H / mm)</b>	106
<b>TP (Plattengröße / mm)</b>	102x83
<b>HS (Lochabstand / mm)</b>	80x60
<b>HD (Loch-Ø / mm)</b>	9
<b>WB (Radlager)</b>	Gleitlager