

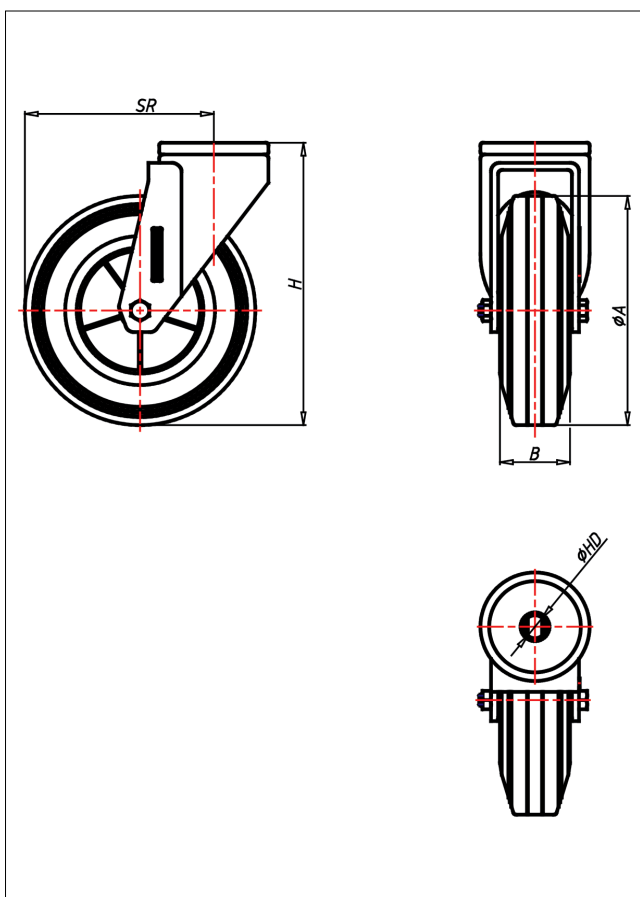

CR-DGB/DG

Lenkrolle



CR-DG



LENKROLLE	LENKROLLE MIT TOTALFESTSTELLER																					
																						
<ul style="list-style-type: none"> • spurfrei - bodenschonend • hoher Fahrkomfort • sehr lauffähig • geringer Rollwiderstand • abriebfest ELASTIK-Vollgummi Felge Kunststoff → Seite 262	 zweifaches Kugellager - vernietet Stahlkugeln gehärtet Radachse verschraubt, verzinkt → Seite 62	AUSWAHLHILFE: <table border="1"> <tr> <td>leicht lenkend</td> <td><input checked="" type="checkbox"/></td> <td><input type="checkbox"/></td> <td><input type="checkbox"/></td> </tr> <tr> <td>verschleißarm</td> <td><input checked="" type="checkbox"/></td> <td><input type="checkbox"/></td> <td><input type="checkbox"/></td> </tr> <tr> <td>stoßfest</td> <td><input checked="" type="checkbox"/></td> <td><input type="checkbox"/></td> <td><input type="checkbox"/></td> </tr> <tr> <td>bodenschonend</td> <td><input checked="" type="checkbox"/></td> <td><input type="checkbox"/></td> <td><input type="checkbox"/></td> </tr> <tr> <td>witterungsbeständig</td> <td><input checked="" type="checkbox"/></td> <td><input type="checkbox"/></td> <td><input type="checkbox"/></td> </tr> </table>	leicht lenkend	<input checked="" type="checkbox"/>	<input type="checkbox"/>	<input type="checkbox"/>	verschleißarm	<input checked="" type="checkbox"/>	<input type="checkbox"/>	<input type="checkbox"/>	stoßfest	<input checked="" type="checkbox"/>	<input type="checkbox"/>	<input type="checkbox"/>	bodenschonend	<input checked="" type="checkbox"/>	<input type="checkbox"/>	<input type="checkbox"/>	witterungsbeständig	<input checked="" type="checkbox"/>	<input type="checkbox"/>	<input type="checkbox"/>
leicht lenkend	<input checked="" type="checkbox"/>	<input type="checkbox"/>	<input type="checkbox"/>																			
verschleißarm	<input checked="" type="checkbox"/>	<input type="checkbox"/>	<input type="checkbox"/>																			
stoßfest	<input checked="" type="checkbox"/>	<input type="checkbox"/>	<input type="checkbox"/>																			
bodenschonend	<input checked="" type="checkbox"/>	<input type="checkbox"/>	<input type="checkbox"/>																			
witterungsbeständig	<input checked="" type="checkbox"/>	<input type="checkbox"/>	<input type="checkbox"/>																			

Technische Details

ORDERNO (Artikel-nummer)	CR 100 DGB
WDAB (Rad-Ø A x Breite B / mm)	100x30
LC (Tragkraft / kg)	85
H (Bauhöhe H / mm)	128
HD (Loch-Ø / mm)	12.5
SR (Schwenkradius / mm)	87
WB (Radlager)	Rollenlager