

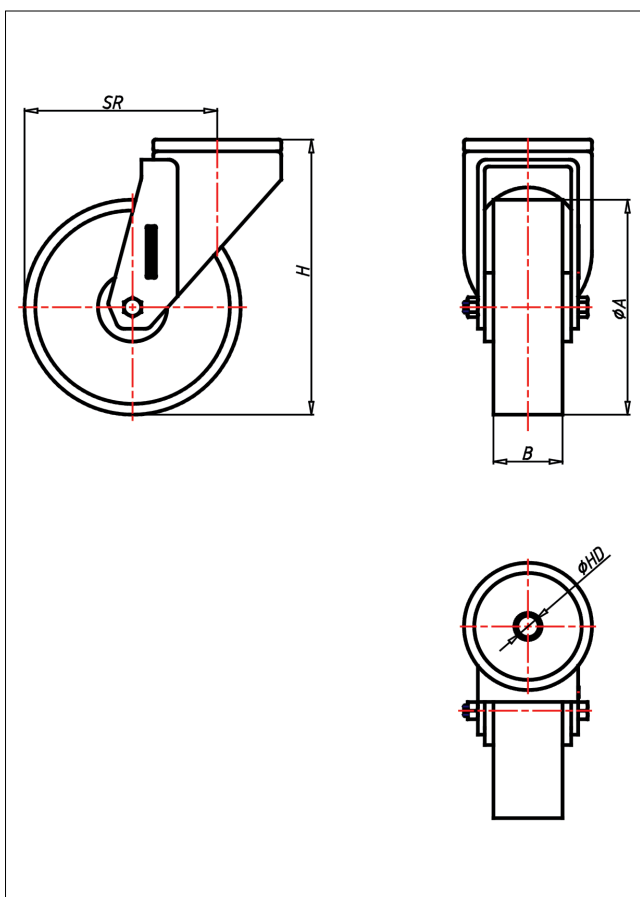

CR/CRS- P/PK/PB/PL/PLLB Lenkrolle



CR-P



LENKROLLE	LENKROLLE MIT TOTALFESTSTELLER																					
<ul style="list-style-type: none"> • leichter Lauf auf glatten Böden • stoß- und schlagfest • hohe Abriebfestigkeit • leicht zu reinigen • sehr beständig gegen viele aggressive Medien Polyamid 6 - 1. Wahl → Seite 272	zweifaches Kugellager - vernietet Stahlkugeln gehärtet Radachse verschraubt, verzinkt → Seite 52	AUSWAHLHILFE: <table border="1"> <tr> <td>leicht lenkend</td> <td>+</td> <td>-</td> <td>++</td> </tr> <tr> <td>verschleißarm</td> <td>x</td> <td></td> <td></td> </tr> <tr> <td>stoßfest</td> <td></td> <td>x</td> <td></td> </tr> <tr> <td>bodenschonend</td> <td></td> <td>x</td> <td></td> </tr> <tr> <td>witterungsbeständig</td> <td>x</td> <td></td> <td></td> </tr> </table>	leicht lenkend	+	-	++	verschleißarm	x			stoßfest		x		bodenschonend		x		witterungsbeständig	x		
leicht lenkend	+	-	++																			
verschleißarm	x																					
stoßfest		x																				
bodenschonend		x																				
witterungsbeständig	x																					

Technische Details

ORDERNO (Artikel-nummer)	CR 100 PL
WDAB (Rad-Ø A x Breite B / mm)	100x30
LC (Tragkraft / kg)	120
H (Bauhöhe H / mm)	128
HD (Loch-Ø / mm)	12.5
SR (Schwenkradius / mm)	87
WB (Radlager)	Nylon-Gleitlager