

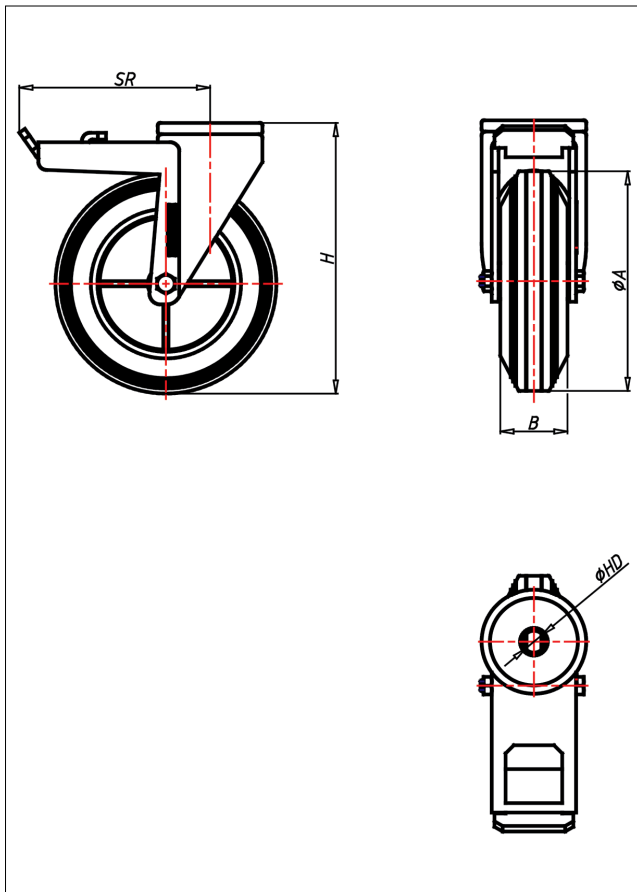

CRT-CGB/CGK

Lenkrolle mit Totalfeststeller



CR-CG



LENKROLLE	LENKROLLE MIT TOTALFESTSTELLER	
<ul style="list-style-type: none"> • spurfrei - bodenschonend • hoher Fahrkomfort • sehr lauffähig • geringer Rollwiderstand • abriebfest 	<ul style="list-style-type: none"> • zweifaches Kugellager - vernietet • Stahlkugeln gehärtet • Radachse verschraubt, verzinkt 	<p>AUSWAHLHILFE:</p> <ul style="list-style-type: none"> leicht lenkend <input checked="" type="checkbox"/> verschleißarm <input checked="" type="checkbox"/> stoßfest <input checked="" type="checkbox"/> bodenschonend <input checked="" type="checkbox"/> witterungsbeständig <input checked="" type="checkbox"/>
<p>ELASTIK-Vollgummi Felge Stahlblech verzinkt → Seite 263</p>	<p>→ Seite 62</p>	

Technische Details

ORDERNO (Artikel-nummer)	CRT 100 CGK
WDAB (Rad-Ø A x Breite B / mm)	100x30
LC (Tragkraft / kg)	90
H (Bauhöhe H / mm)	128
HD (Loch-Ø / mm)	12.5
SR (Schwenkradius / mm)	108
WB (Radlager)	Kugellager