

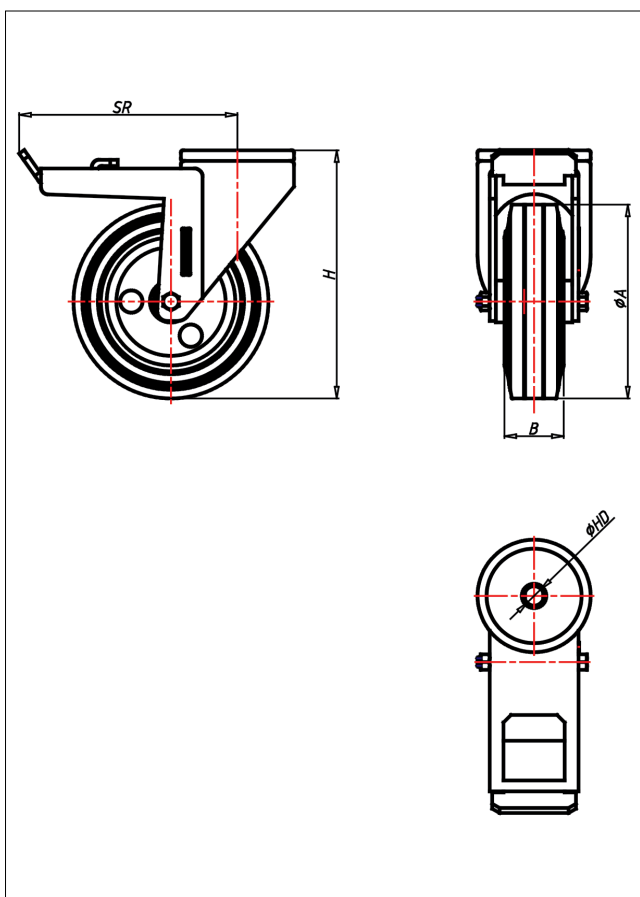

CRT/CRST-ELB/ELK

Lenkrolle mit Totalfeststeller



CR-EL



LENKROLLE	LENKROLLE MIT TOTALFESTSTELLER	
<ul style="list-style-type: none"> • elektrisch leitfähig • Widerstand <math>10^4 \Omega</math> • geräuscharmer Lauf • großer Fahrkomfort • beständig gegen verdünnte Säuren Vollgummi schwarz Felge Stahlblech verzinkt → Seite 267	<ul style="list-style-type: none"> • zweifaches Kugellager - vernietet • Stahlkugeln gehärtet • Radachse verschraubt, verzinkt → Seite 62	AUSWAHLHILFE: <ul style="list-style-type: none"> leicht lenkend <input checked="" type="checkbox"/> verschleißsam <input checked="" type="checkbox"/> stoßfest <input checked="" type="checkbox"/> bodenschonend <input checked="" type="checkbox"/> witterungsbeständig <input checked="" type="checkbox"/>

Technische Details

ORDERNO (Artikel-nummer)	CRT 200 ELK
WDAB (Rad-Ø A x Breite B / mm)	200x50
LC (Tragkraft / kg)	205
H (Bauhöhe H / mm)	240
HD (Loch-Ø / mm)	12.5
SR (Schwenkradius / mm)	168
WB (Radlager)	Kugellager