

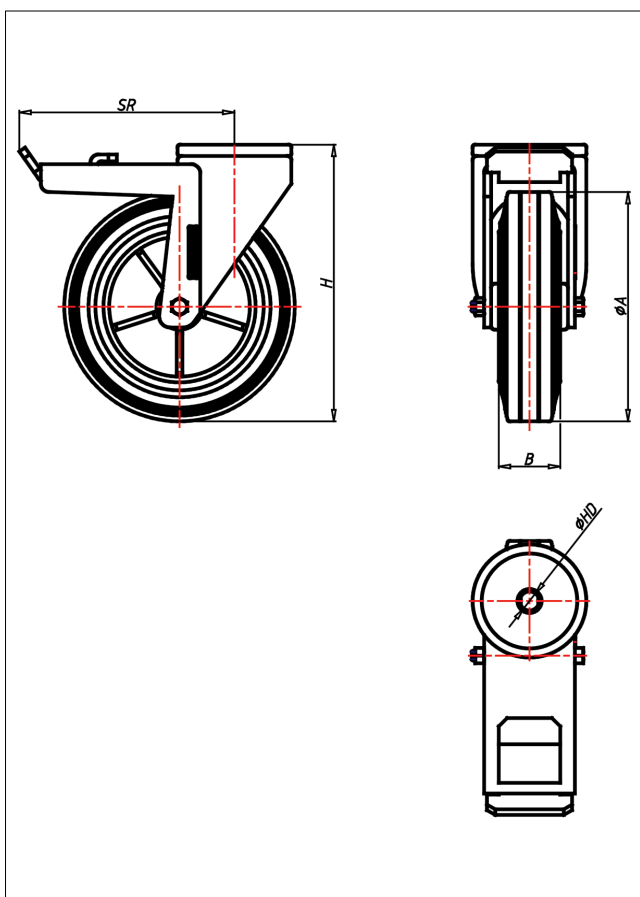

CRT-DB/D

Lenkrolle mit Totalfeststeller



CR-D



LENKROLLE	LENKROLLE MIT TOTALFESTSTELLER	
<ul style="list-style-type: none"> • geräuscharmer Lauf • großer Fahrkomfort • beständig gegen verdünnte Säuren Vollgummi schwarz Felge Kunststoff schwarz → Seite 255	<ul style="list-style-type: none"> • zweifaches Kugellager - vernietet • Stahlkugeln gehärtet • Radachse verschraubt, verzinkt → Seite 62	AUSWAHLHILFE: <ul style="list-style-type: none"> leicht lenkend <input type="checkbox"/> verschleißarm <input type="checkbox"/> stoßfest <input type="checkbox"/> bodenschonend <input type="checkbox"/> witterungsbeständig <input type="checkbox"/>

Technische Details

ORDERNO (Artikel-nummer)	CRT 80 DB
WDAB (Rad-Ø A x Breite B / mm)	80x25
LC (Tragkraft / kg)	50
H (Bauhöhe H / mm)	106
HD (Loch-Ø / mm)	12.5
SR (Schwenkradius / mm)	108
WB (Radlager)	Rollenlager