

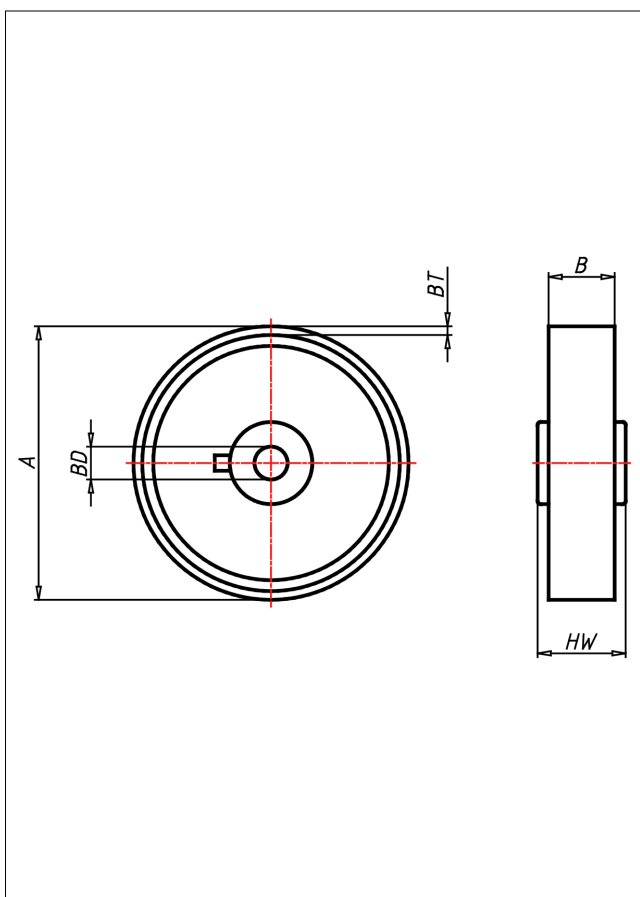

AL Rad

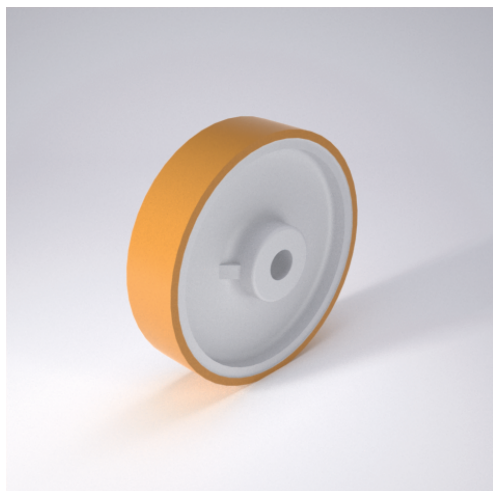

AL



Radkörper aus Polyamid 6 - 1. Wahl
Laufbelag aus Spritzguss-Polyurethan,
58±3 Shore D

- geringer Rollwiderstand
- abrieb- und reifest
- leichte Reinigung
- sehr beständig gegen viele aggressive Medien

Technische Details

ORDERNO (Artikel-nummer)	100 ALBX 15
WDAB (Rad-Ø A x Breite B / mm)	100x30
LC (Tragkraft / kg)	160
BT (Reifenstärke / mm)	2.5
HW (Nabellänge / mm)	40
FL (Einbaulänge / mm)	40
WB (Radlager)	INOX-Rollenlager
BD (Bohrungsdurchmesser / mm)	15