

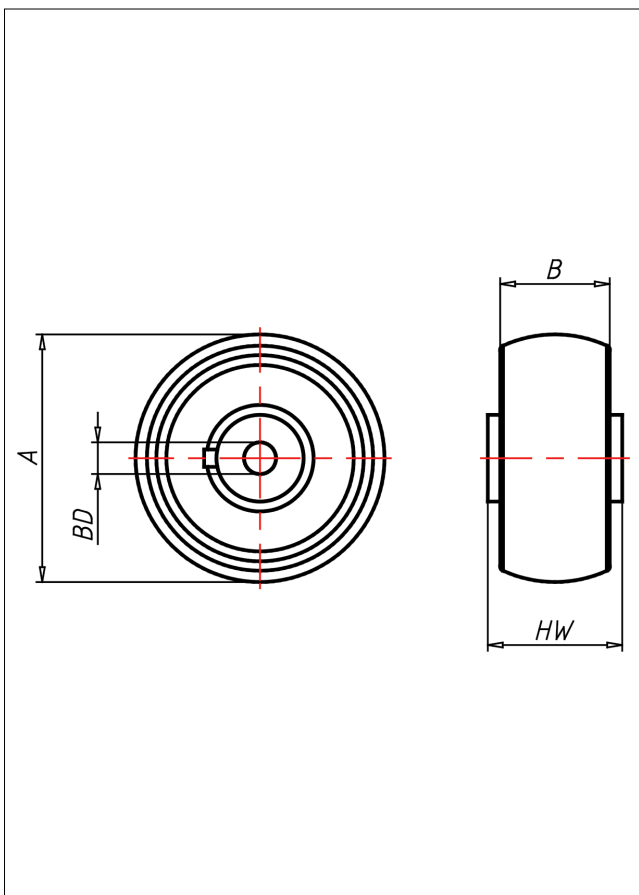

# CI/Q Rad

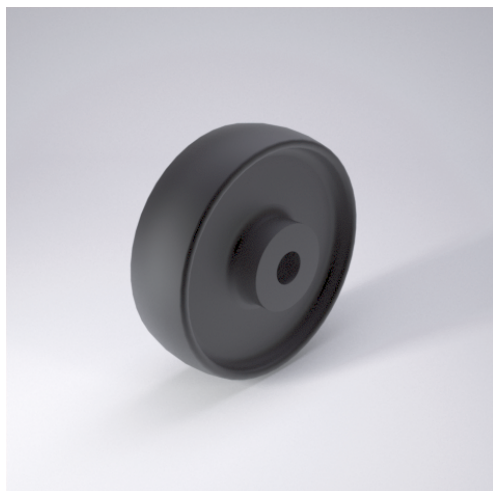

CI/Q



+300 °C\*\*  
-40 °C max. 7000 kg



Lackiertes Gusseisenrad, ballig überdrehte Lauffläche

- leichter Lauf auf glatten Böden
- sehr hohe Tragkraft
- sehr abriebfest
- mit Gleit- oder Kugellager für hohe Temperaturen

## Technische Details

<b>ORDERNO (Artikel-nummer)</b>	100 QK 15
<b>WDAB (Rad-Ø A x Breite B / mm)</b>	100x32
<b>LC (Tragkraft / kg)</b>	500
<b>HW (Nabellänge / mm)</b>	30
<b>FL (Einbaulänge / mm)</b>	30
<b>WB (Radlager)</b>	2 Rillen-Kugellager 6202 ZZ
<b>BD (Bohrungsdurchmesser / mm)</b>	15