

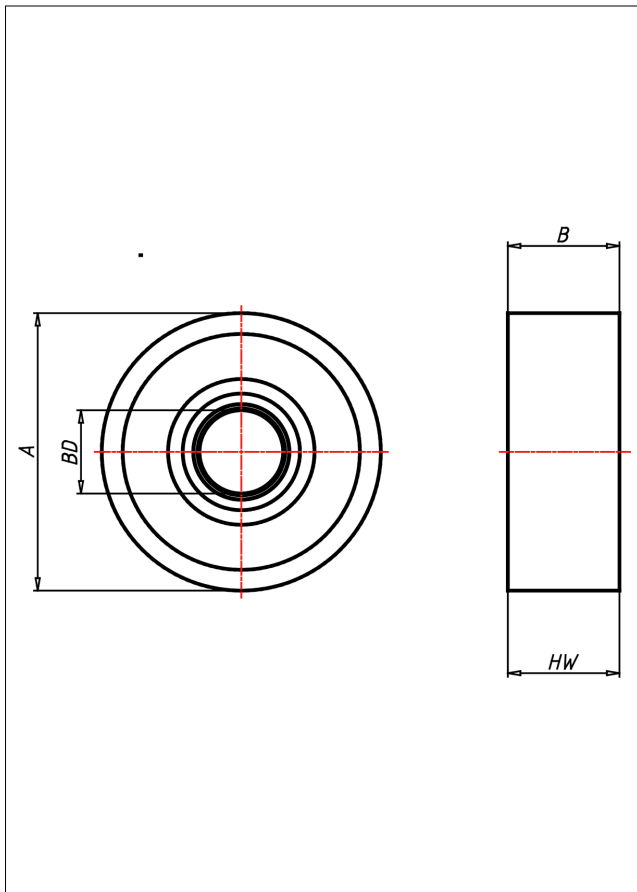

SFT Schienenrad



SFT Schienenrad



+350 °C
-30 °C max.
50400 kg

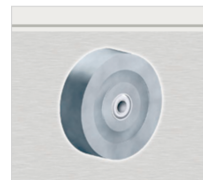

Schienenrad aus Stahl BS 970
Lauffläche sauber überdreht

- sehr hohe Tragkraft
- sehr abriebfest
- für hohe Temperaturen

Technische Details

ORDERNO (Artikel-nummer)	100 SFTTM 25
WDAB (Rad-Ø A x Breite B / mm)	100x60
LC (Tragkraft / kg)	3600
HW (Nabellänge / mm)	60
WB (Radlager)	Schräggrollenlager
BD (Bohrungsdurchmesser / mm)	25