

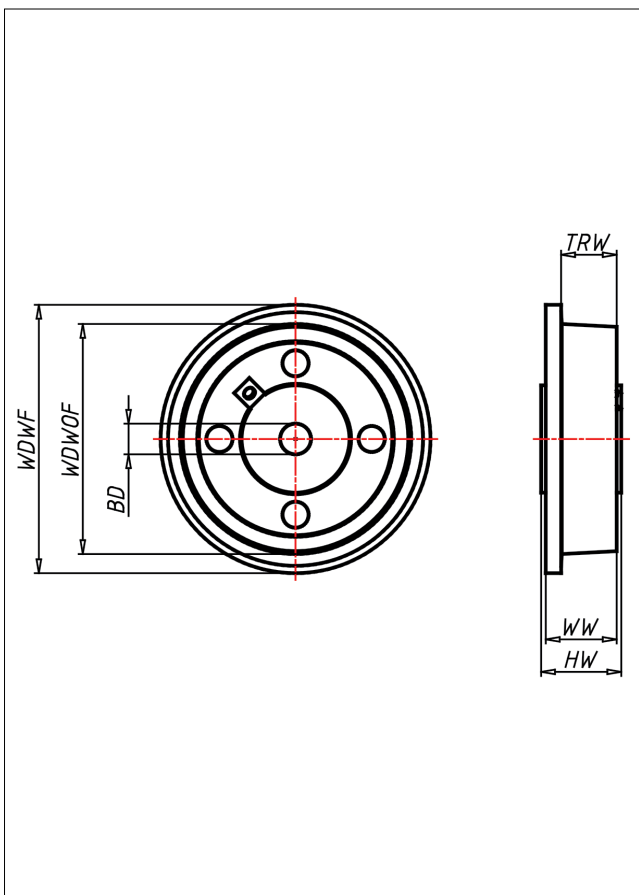

SP Spurkranzrad

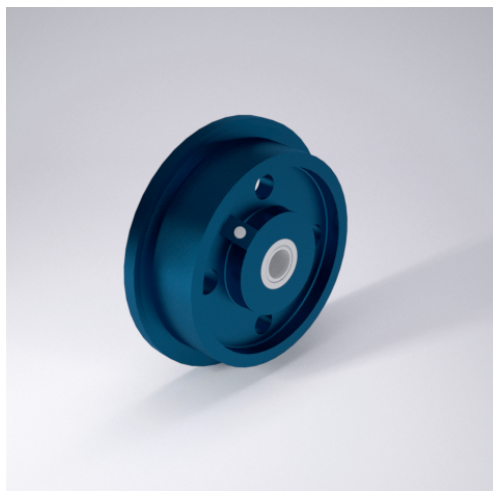

SP Spurkranzrad



Spurkranzrad aus Eisenguss
Lauffläche sauber überdreht, Neigungswinkel 3°
Ausführung lackiert

- sehr hohe Tragkraft
- sehr abriebfest
- für hohe Temperaturen

Technische Details

| | |
|---------------------------------|------------|
| ORDERNO (Artikel-nummer) | 100 SPK 20 |
| WDWOF (Rad-Ø o. Spurkranz / mm) | 100 |
| WDWF (Rad-Ø m. Spurkranz / mm) | 125 |
| TRW (Laufflächenbreite / mm) | 36 |
| WW (Radbreite / mm) | 46 |
| LC (Tragkraft / kg) | 800 |
| HW (Nabellänge / mm) | 52 |
| WB (Radlager) | Kugellager |
| BD (Bohrungsdurchmesser / mm) | 20 |