

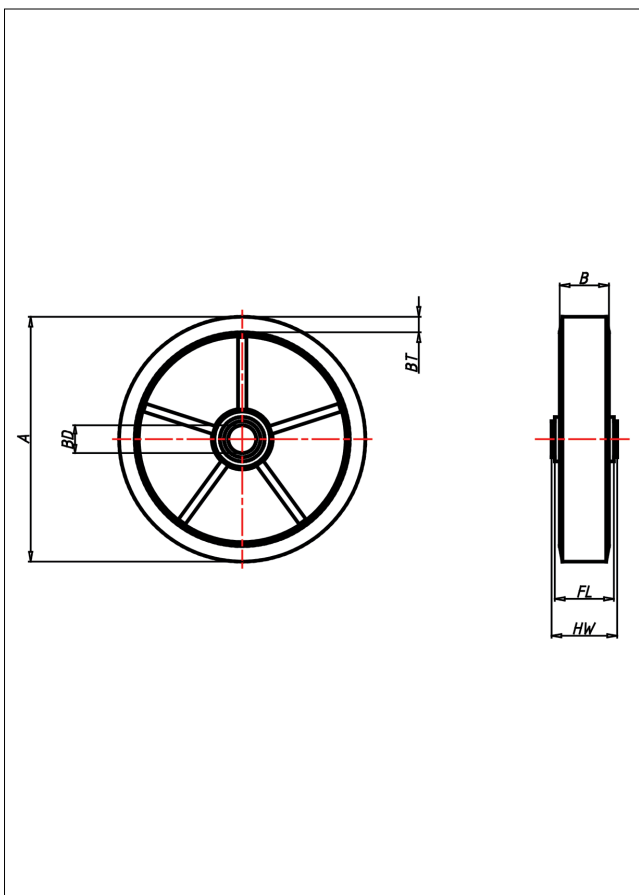

# ZS Rad

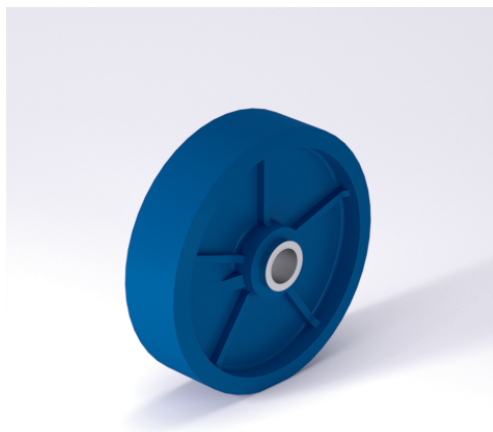

ZS



Radkörper aus Gussseisen lackiert  
Laufbelag aus weichen Guss-Polyurethan 85s3  
Shore A

Cast-iron wheel centre - painted  
Coated in soft cast polyurethane, 85s3 Shore A

- sehr geräuscharmer Lauf
- geringer Rollwiderstand
- abrieb- und reißfest
- hohe Stoßfestigkeit
- sehr beständig gegen viele aggressive Medien

- very silent in motion
- low rolling resistance
- high abrasion and tear resistance
- high resistance to shocks
- good chemical resistance

### Technische Details

ORDERNO (Artikel-nummer)	101 ZSK 20
WDAB (Rad-Ø A x Breite B / mm)	100x40
LC (Tragkraft / kg)	240
HW (Nabellänge / mm)	40
FL (Einbaulänge / mm)	40
WB (Radlager)	2 Rillen-Kugellager 6204 ZZ
BD (Bohrungsdurchmesser / mm)20	