

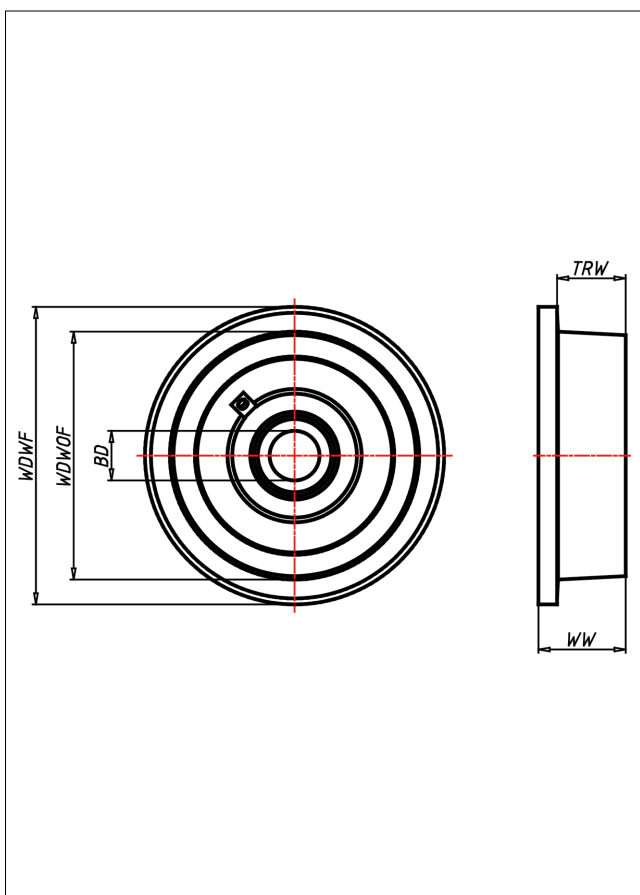

SFH Spurkranzrad

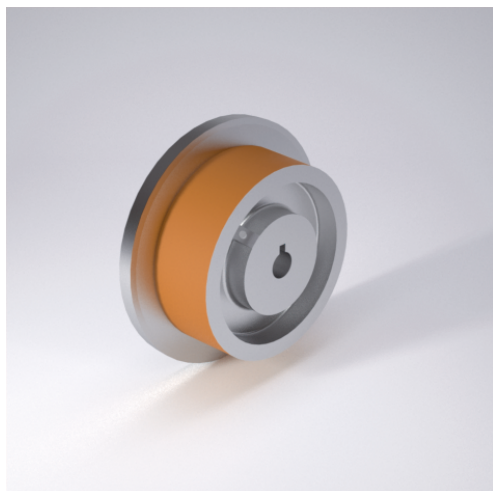

SFH Spurkranzrad



+60 °C
-30 °C max. 1200 kg



Radkörper aus Stahl BS970
Vulkollan® 92:3 Shore A
kurzfristig hitzebeständig bis 115° C

- geräuscharmer Lauf
- geringer Rollwiderstand
- abrieb- und reißfest
- hohe Stoßfestigkeit
- sehr beständig gegen viele aggressive Medien

Technische Details

ORDERNO (Artikel-nummer)	125 SFHK 20
WDWOF (Rad-Ø o. Spurkranz / mm)	125
WDFW (Rad-Ø m. Spurkranz / mm)	155
TRW (Laufflächenbreite / mm)	45
WW (Radbreite / mm)	57
HW (Nabellänge / mm)	57
WB (Radlager)	Kugellager
LC (Tragkraft / kg)	600
BD (Bohrungsdurchmesser / mm)	20