

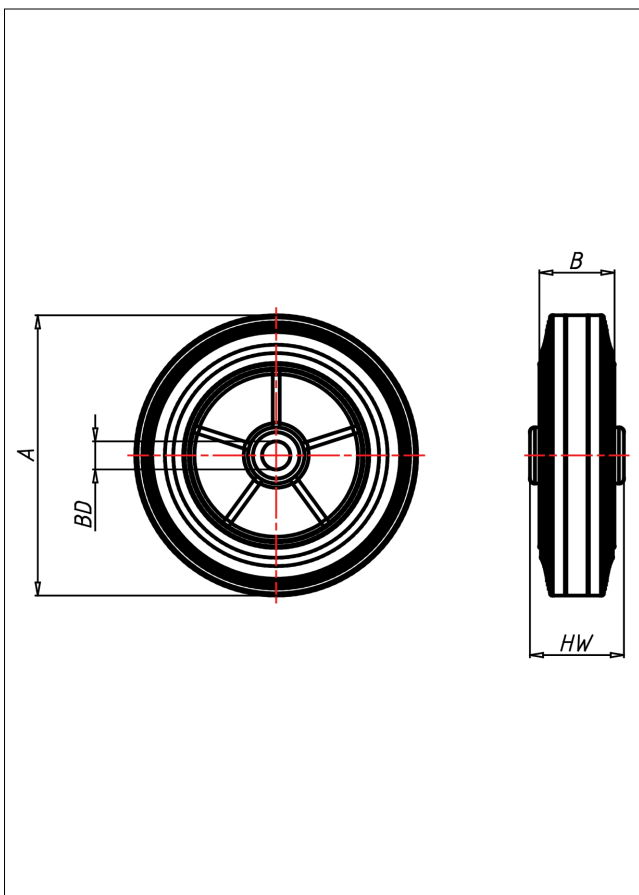

# D Rad

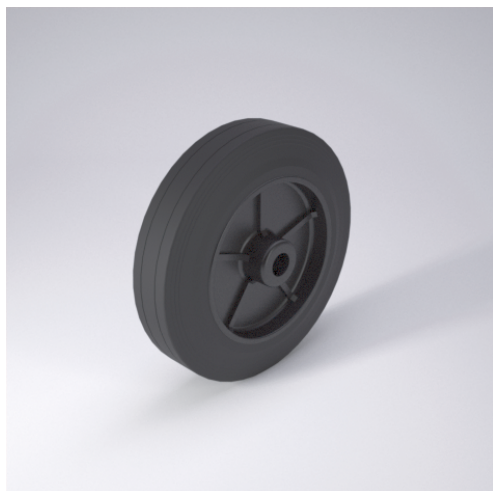

D



+60 °C  
-20 °C max. 285 kg

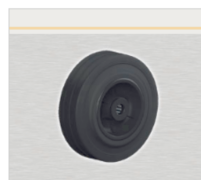

Radkörper aus hochwertigem schwarzem Kunststoff, Vollgummireifen schwarz, 85±5 Shore A

- geräuscharmer Lauf
- großer Fahrkomfort
- beständig gegen verdünnte Säuren

## Technische Details

ORDERNO (Artikel-nummer)	126 D-15
WDAB (Rad-Ø A x Breite B / mm)	125x38
LC (Tragkraft / kg)	100
HW (Nabellänge / mm)	50
FL (Einbaulänge / mm)	50
WB (Radlager)	Polyamid-Gleitlager
BD (Bohrungsdurchmesser / mm)	15