

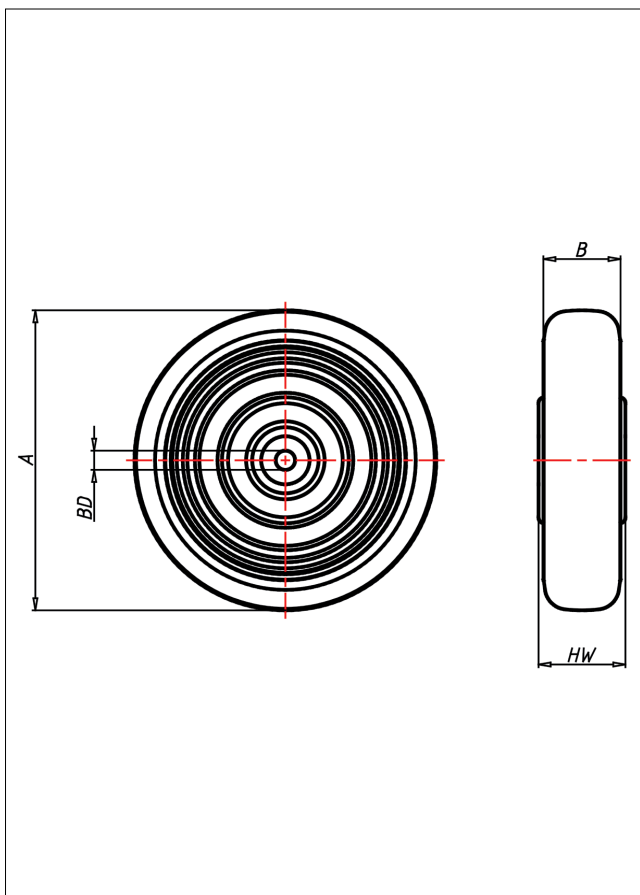

AEL Rad

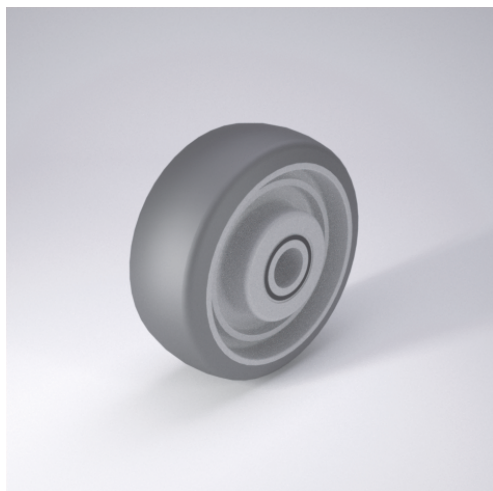

AEL



Radkörper aus Polyamid 6 - 1. Wahl
Laufbelag aus Polyurethan, 90±3 Shore A
elektrisch leitfähig

- elektrisch leitfähig
- geräuscharmer Lauf
- geringer Rollwiderstand
- spurfrei
- hohe Stoßfestigkeit
- sehr beständig gegen viele aggressive Medien

Technische Details

ORDERNO (Artikel-nummer)	127 AELK 8
WDAB (Rad-Ø A x Breite B / mm)	125x32
LC (Tragkraft / kg)	160
HW (Nabellänge / mm)	36
FL (Einbaulänge / mm)	36
WB (Radlager)	2 Rillen-Kugellager 6201 2RS
BD (Bohrungsdurchmesser / mm)	8