

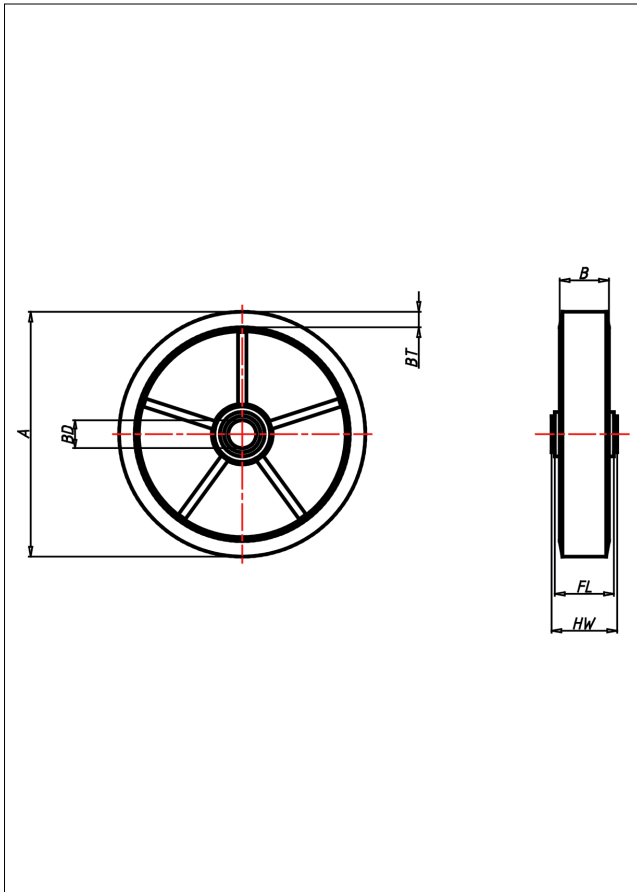

Z/SU Rad



Z/SU



Z

Radkörper aus Gusseisen lackiert
Laufbelag aus Guss-Polyurethan 95±3 Shore A

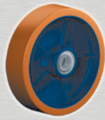

- geräuscharmer Lauf
- geringer Rollwiderstand
- abrieb- und reißfest
- hohe Stoßfestigkeit
- sehr beständig gegen viele aggressive Medien

Technische Details

| | |
|---------------------------------------|-----------------------------|
| ORDERNO (Artikel-nummer) | 127 ZK 25 |
| WDAB (Rad-Ø A x Breite B / mm) | 125x50 |
| LC (Tragkraft / kg) | 480 |
| BT (Reifenstärke / mm) | 10 |
| HW (Nabellänge / mm) | 50 |
| FL (Einbaulänge / mm) | 40 |
| WB (Radlager) | 2 Rillen-Kugellager 6005 ZZ |
| BD (Bohrungsdurchmesser / mm) | 25 |