

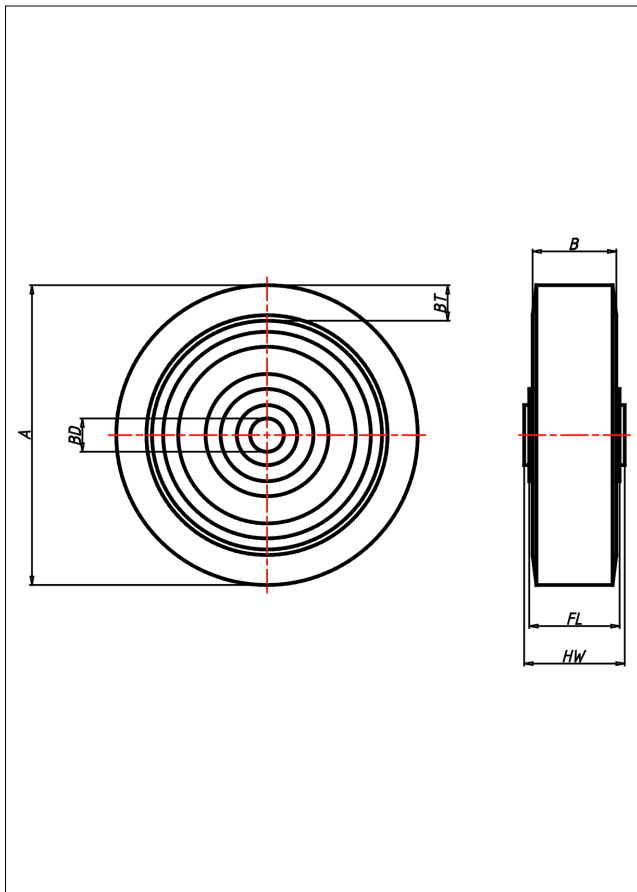

RN Rad

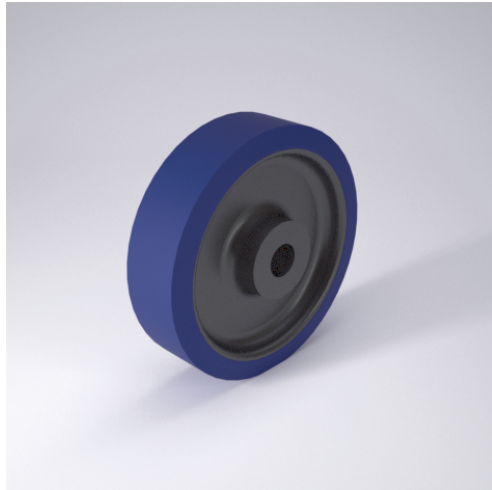

RN



+70 °C
-20 °C max. 480 kg

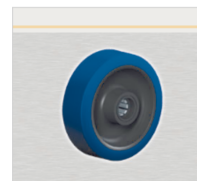

Radkörper aus Polyamid 6 - 1. Wahl, schwarz
Elastik-Vollgummireifen, blau, 73±5 Shore A
aufvulkanisiert

- hoher Fahrkomfort
- sehr lauffähig
- geringer Rollwiderstand
- abriebfest
- korrosionsbeständig
- spurfrei

Technische Details

ORDERNO (Artikel-nummer)	150 RNK 15
WDAB (Rad-Ø A x Breite B / mm)	150x40
LC (Tragkraft / kg)	240
BT (Reifenstärke / mm)	12.5
HW (Nabellänge / mm)	50
FL (Einbaulänge / mm)	48
WB (Radlager)	2 Rillen-Kugellager 6202 ZZ
BD (Bohrungsdurchmesser / mm)	15