

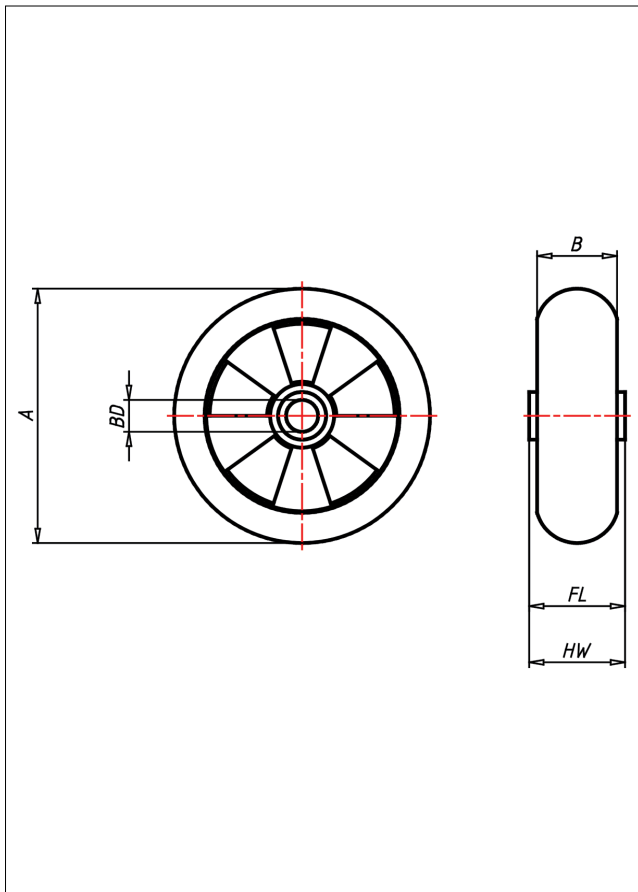

EGBA Rad

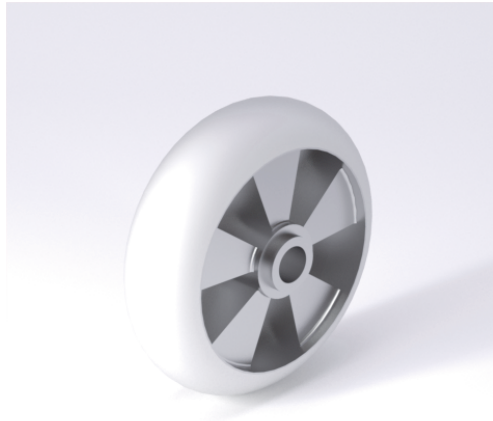

EGBA



+80 °C
-25 °C
max.
400 kg



Radkörper aus Spritzguss-Aluminium-Legierung
SUPER-Elastik-Vollgummireifen 55 ± 3 Shore A
weich, lauffläche baugig

Core in die-cast aluminium alloy
SUPER-Elastic solid rubber tyre black 55 ± 3
Shore A soft, crowned tread

- sehr geräuscharmer Lauf
- sehr geringer Rollwiderstand
- abriebfest
- korrosionsbeständig
- Alternative zu Luftreifen
- SPURFREI

- very silent in motion
- very low rolling resistance
- good abrasion resistance
- corrosion resistant
- alternative to pneumatic tires
- non-marking

Technische Details

ORDERNO (Artikel-nummer)	160 EGBAK K20
WDAB (Rad-Ø A x Breite B / mm)	160x50
LC (Tragkraft / kg)	270
HW (Nabellänge / mm)	60
FL (Einbaulänge / mm)	60
WB (Radlager)	Ball bearing
BD (Bohrungsdurchmesser / mm)	20