

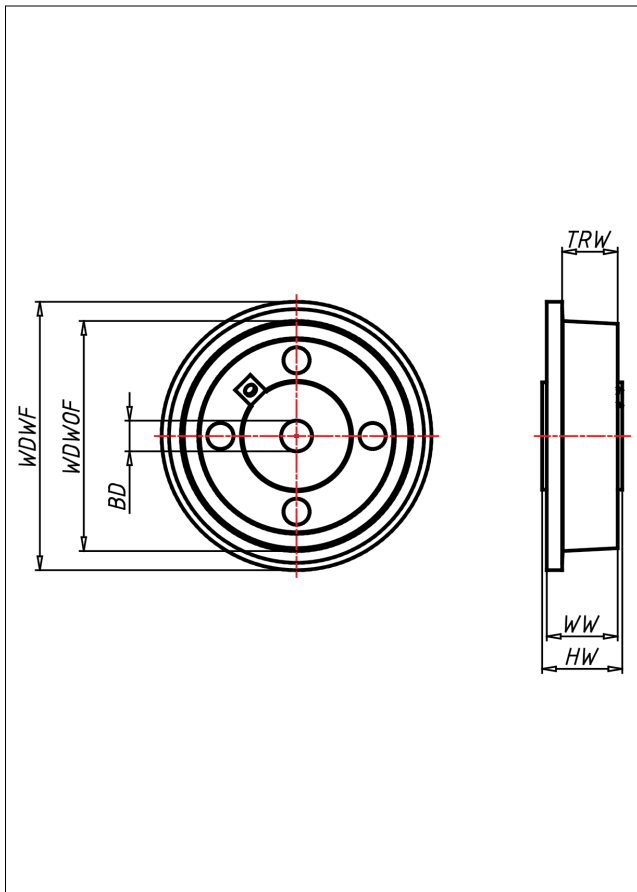

SP Spurkranzrad

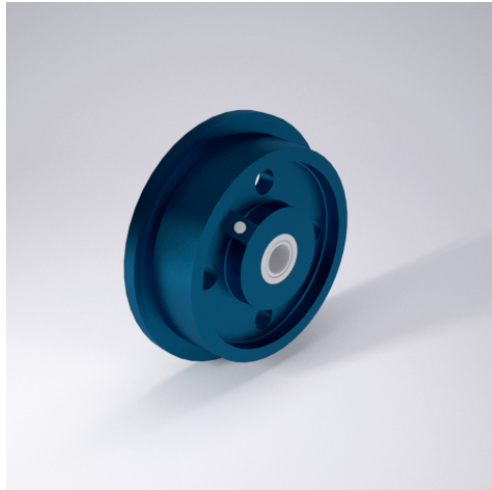

SP Spurkranzrad



+300 °C*
-40 °C max. 3000 kg

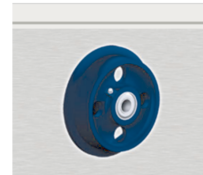

Spurkranzrad aus Eisenguss
Lauffläche sauber überdreht, Neigungswinkel 3°
Ausführung lackiert

- sehr hohe Tragkraft
- sehr abriebfest
- für hohe Temperaturen

Technische Details

ORDERNO (Artikel-nummer)	180 SP-30
WDWOF (Rad-Ø o. Spurkranz / mm)	180
WDWF (Rad-Ø m. Spurkranz / mm)	210
TRW (Laufflächenbreite / mm)	36
WW (Radbreite / mm)	48
LC (Tragkraft / kg)	1200
HW (Nabellänge / mm)	52
WB (Radlager)	Gleitlager
BD (Bohrungsdurchmesser / mm)	30