

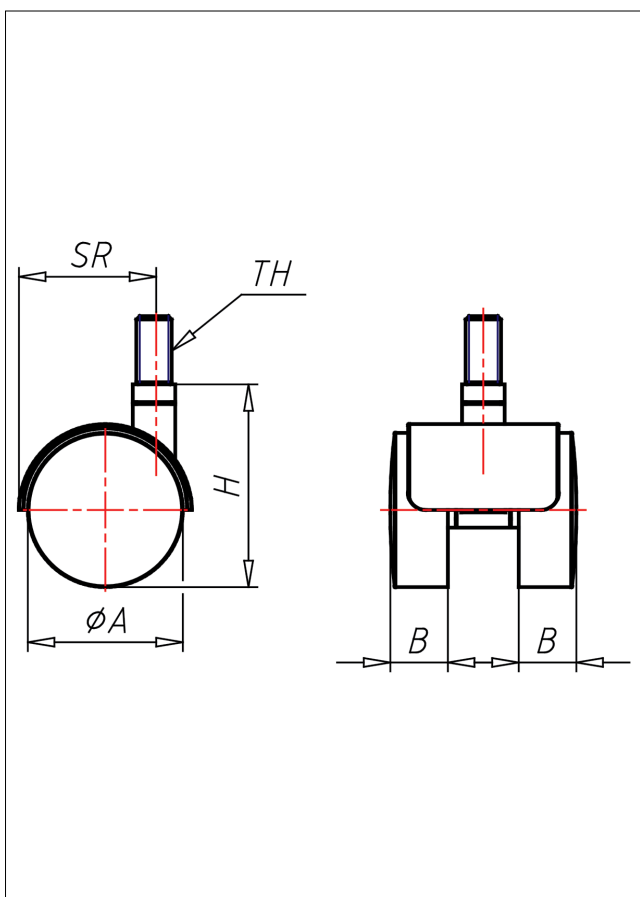

# 1800 M8/M10 G

## Lenkrolle

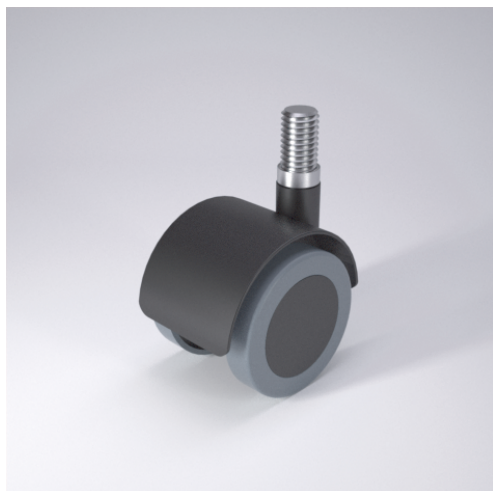

1800-G



+60 °C max.  
-20 °C 70 kg



schwarzes Gehäuse aus hochwertigem Kunststoff  
Schwenklager mit Gleitlager Felge  
aus hochwertigem Kunststoff Rad mit weicher Lauffläche - spurfrei  
Radachse vernietet

### Technische Details

ORDERNO (Artikel-nummer)	1800 M10 35 G
WDAB (Rad-Ø A x Breite B / mm)	35x11+11
LC (Tragkraft / kg)	70
H (Bauhöhe H / mm)	42
TH (Gewinde / mm)	M10x15
SR (Schwenkradius / mm)	39.5
WB (Radlager)	Gleitlager