

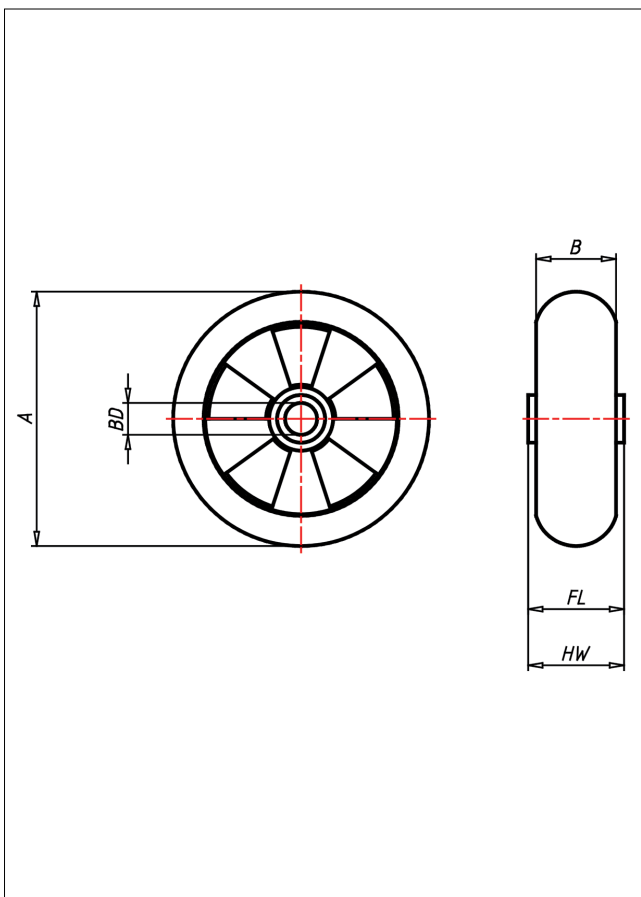

# EBA Rad

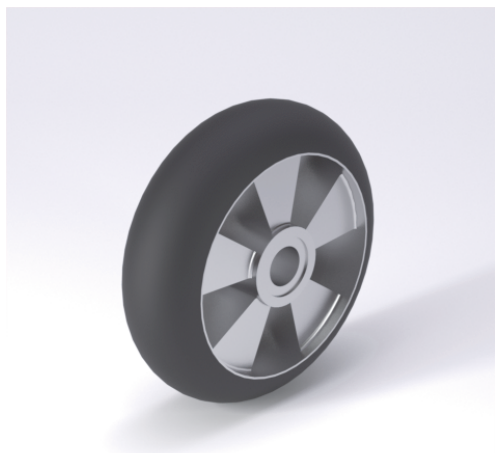

EBA



Radkörper aus Spritzguss-Aluminium-Legierung  
SUPER-Elastik-Vollgummireifen 55 ± 3 Shore A  
weich, Lauffläche baltig

- sehr geräuscharmer Lauf
- sehr geringer Rollwiderstand
- abriebfest
- korrosionsbeständig
- Alternative zu Luftreifen

Core in die-cast aluminium alloy  
SUPER-Elastic solid rubber tyre black 55 ± 3  
Shore A soft, crowned tread

- very silent in motion
- very low rolling resistance
- good abrasion resistance
- corrosion resistant
- alternative to pneumatic tires

## Technische Details

ORDERNO (Artikel-nummer)	200 EBAK K20
WDAB (Rad-Ø A x Breite B / mm)	200x50
LC (Tragkraft / kg)	360
HW (Nabellänge / mm)	60
FL (Einbaulänge / mm)	60
WB (Radlager)	Ball bearing
BD (Bohrungsdurchmesser / mm)	20