

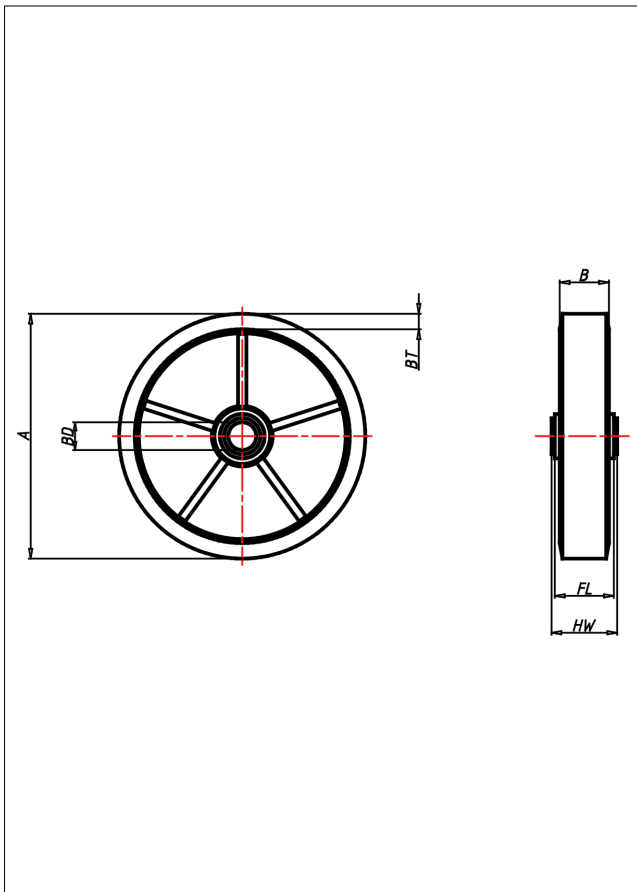

Z/SU Rad



Z/SU



Z

Radkörper aus Gusseisen lackiert
Laufbelag aus Guss-Polyurethan 95:3 Shore A

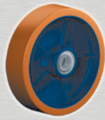

- geräuscharmer Lauf
- geringer Rollwiderstand
- abrieb- und reißfest
- hohe Stoßfestigkeit
- sehr beständig gegen viele aggressive Medien

Technische Details

ORDERNO (Artikel-nummer)	200 LZK 20
WDAB (Rad-Ø A x Breite B / mm)	200x40
LC (Tragkraft / kg)	800
BT (Reifenstärke / mm)	12.5
HW (Nabellänge / mm)	50
FL (Einbaulänge / mm)	44
WB (Radlager)	2 Rillen-Kugellager 6204 ZZ
BD (Bohrungsdurchmesser / mm)	20