

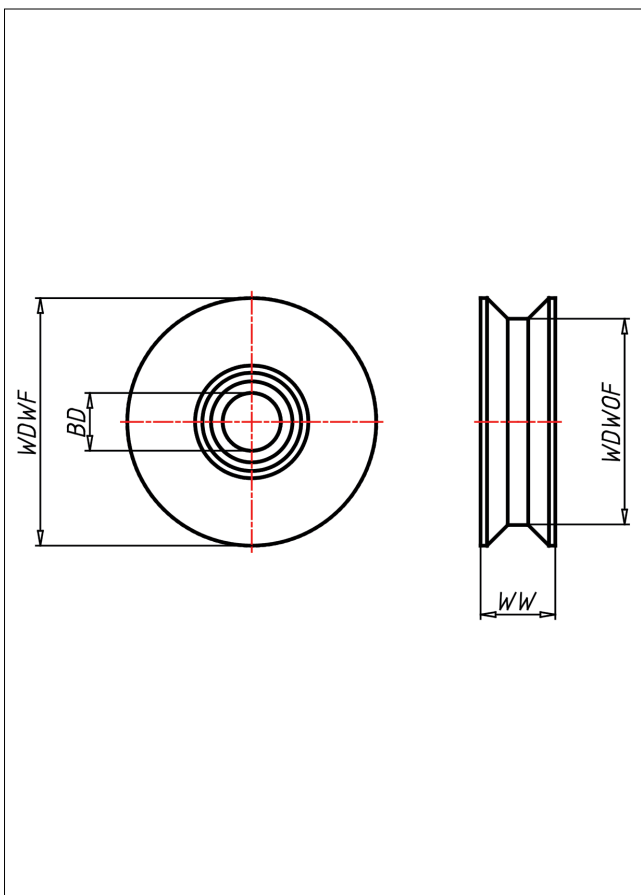

SVT V-Nutrad

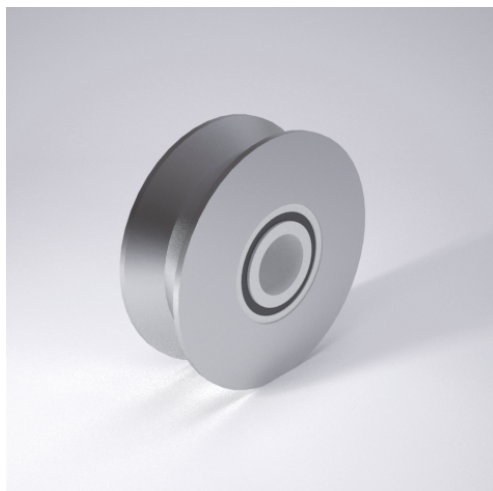

SVT V-Nutrad

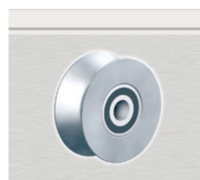

90° V-Nut Rad aus Stahl BS970

- sehr hohe Tragkraft
- sehr abriebfest
- für hohe Temperaturen

Technische Details

ORDERNO (Artikel-nummer)	200 SVT-30
WDWOF (Rad-Ø o. Spurkranz / mm)	168
WDWF (Rad-Ø m. Spurkranz / mm)	200
WW (Radbreite / mm)	50
LC (Tragkraft / kg)	3270
HW (Nabenlänge / mm)	50
WB (Radlager)	Bohrung mit Keilnut
BD (Bohrungsdurchmesser / mm)	30 H7