

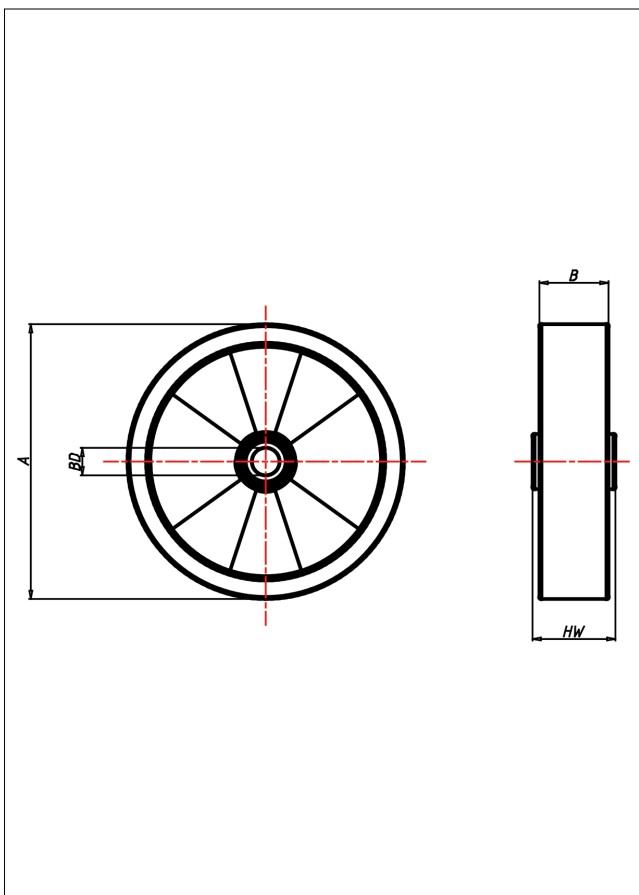

# TLEL Rad

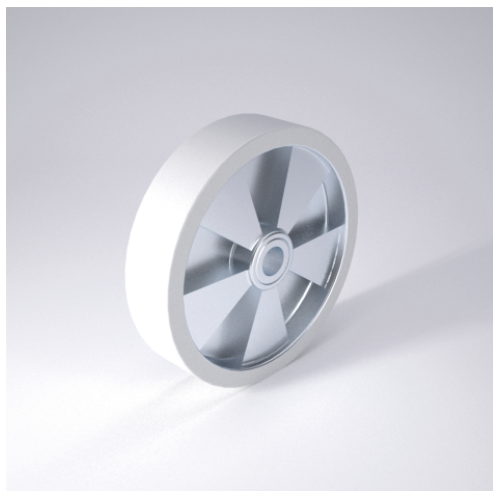

TLEL



Radkörper aus Spritzguss-Aluminium-Legierung  
Laufbelag aus Guss-Polyurethan 95:3 Shore A  
Elektrisch leitfähig

- elektrisch leitfähig
- geräuscharmer Lauf
- geringer Rollwiderstand
- abrieb- und reißfest
- spurfrei
- sehr beständig gegen viele aggressive Medien

## Technische Details

<b>ORDERNO (Artikel-nummer)</b>	200 TLELK 20
<b>WDAB (Rad-Ø A x Breite B / mm)</b>	200x50
<b>LC (Tragkraft / kg)</b>	800
<b>HW (Nabellänge / mm)</b>	60
<b>FL (Einbaulänge / mm)</b>	60
<b>WB (Radlager)</b>	2 Rillen-Kugellager 6205 ZZ
<b>BD (Bohrungsdurchmesser / mm)</b>	20