

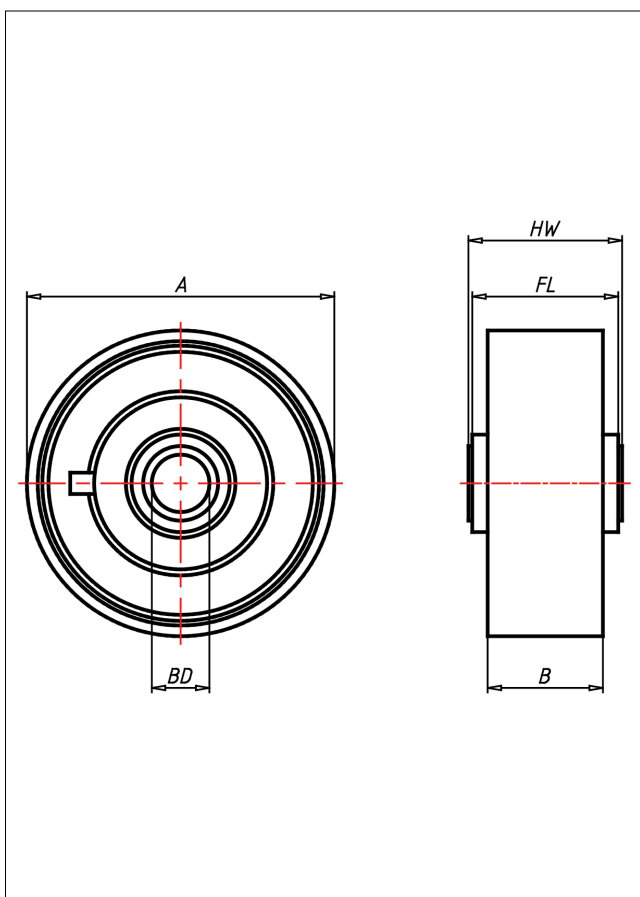

P Rad

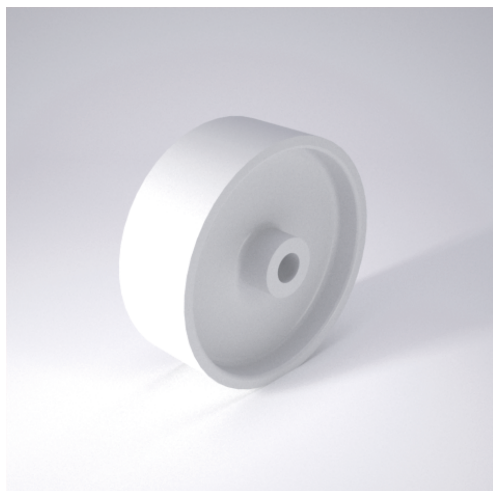

P



+80 °C
-20 °C max.
900 kg

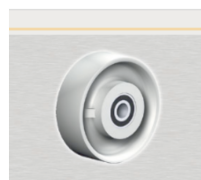

Vollrad aus Polyamid 6 - 1. Wahl

- leichter Lauf auf glatten Böden
- stoß- und schlagfest
- hohe Abriebfestigkeit
- leicht zu reinigen
- sehr beständig gegen viele aggressive Medien

Technische Details

ORDERNO (Artikel-nummer)	201 PK 20
WDAB (Rad-Ø A x Breite B / mm)	200x50
LC (Tragkraft / kg)	1200
HW (Nabellänge / mm)	60
FL (Einbaulänge / mm)	56
WB (Radlager)	2 Rillen-Kugellager 6304 2RS
BD (Bohrungsdurchmesser / mm)	20