

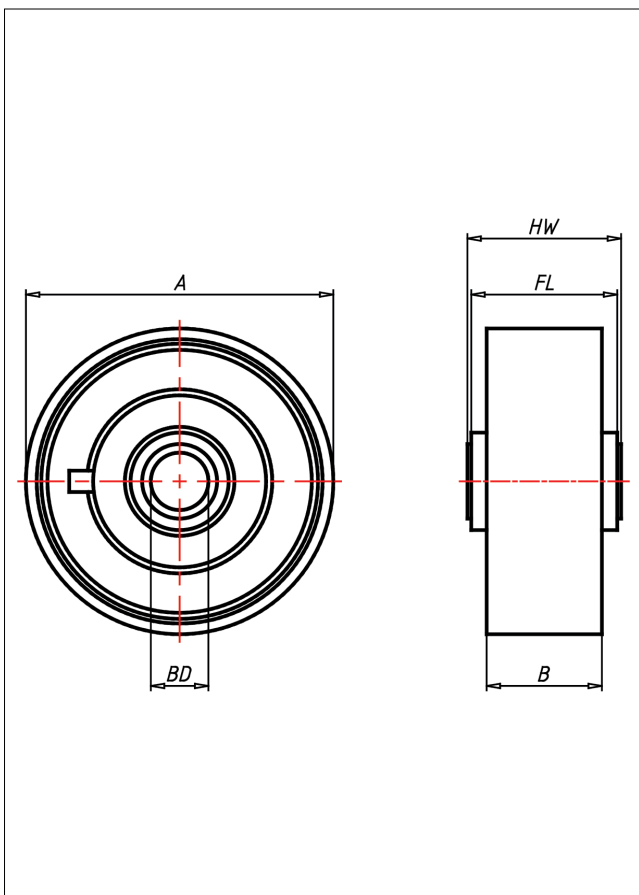

P Rad

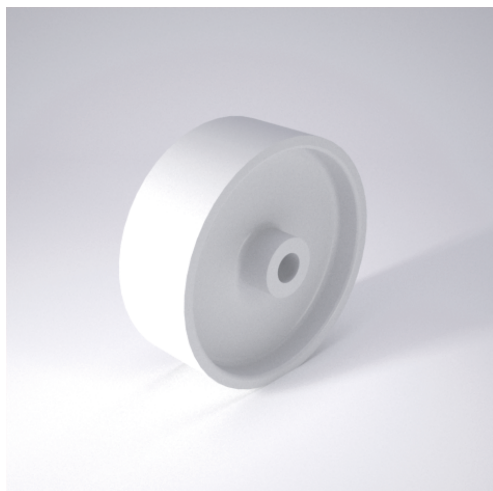

P



+80 °C
-20 °C max.
900 kg

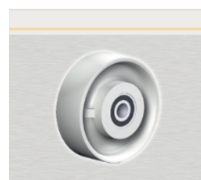

Vollrad aus Polyamid 6 - 1. Wahl

- leichter Lauf auf glatten Böden
- stoß- und schlagfest
- hohe Abriebfestigkeit
- leicht zu reinigen
- sehr beständig gegen viele aggressive Medien

Technische Details

| | |
|---------------------------------------|---------------------------------|
| ORDERNO (Artikel-nummer) | 201 PK 25 |
| WDAB (Rad-Ø A x Breite B / mm) | 200x50 |
| LC (Tragkraft / kg) | 1200 |
| HW (Nabellänge / mm) | 60 |
| FL (Einbaulänge / mm) | 56 |
| WB (Radlager) | 2 Rillen-Kugellager 6205 2RS |
| BD (Bohrungsdurchmesser / mm) | 25 |