

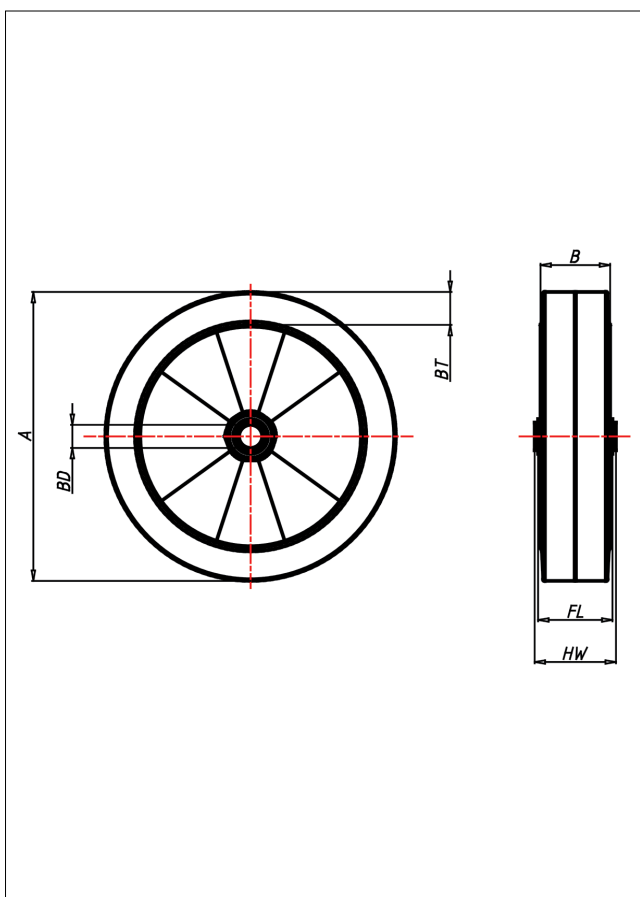

# E Rad



E



Radkörper aus Spritzguss-Aluminiumlegierung  
Elastik-Vollgummireifen, schwarz oder grau,  
73±5 Shore A, aufvulkanisiert

- hoher Fahrkomfort
- sehr laufrichtig
- geringer Rollwiderstand
- abriebfest
- korrosionsbeständig
- spurfrei in grau

### Technische Details

<b>ORDERNO (Artikel-nummer)</b>	250 LEB 20
<b>WDAB (Rad-Ø A x Breite B / mm)</b>	250x50
<b>LC (Tragkraft / kg)</b>	530
<b>BT (Reifenstärke / mm)</b>	33
<b>HW (Nabellänge / mm)</b>	60
<b>FL (Einbaulänge / mm)</b>	60
<b>WB (Radlager)</b>	Rollenlager
<b>BD (Bohrungsdurchmesser / mm)</b>	20