

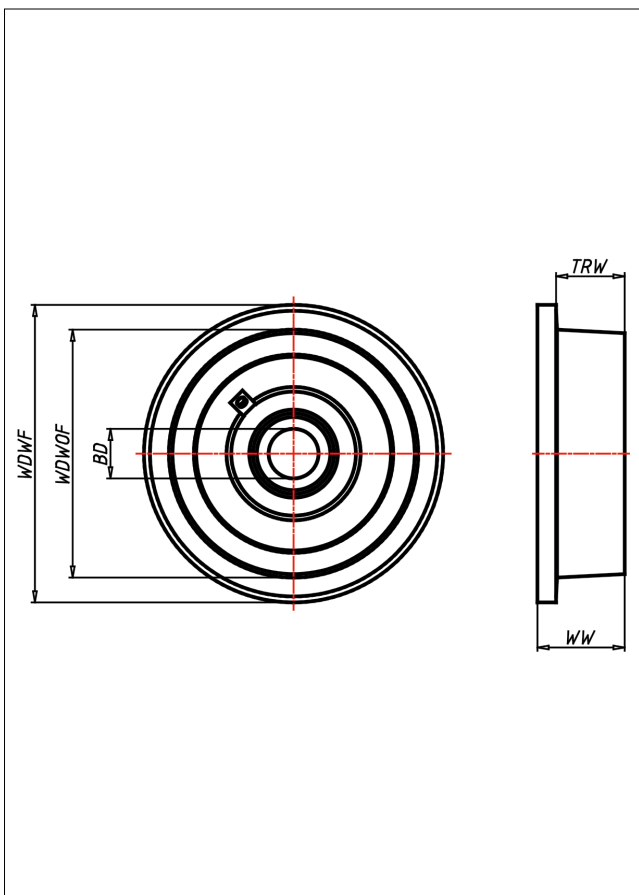

SSF Spurkranzrad

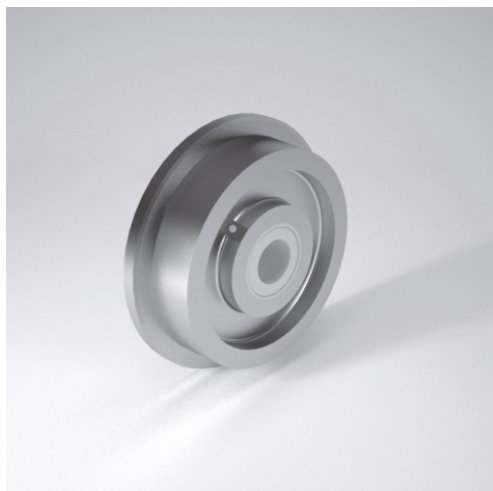

SSF Spurkranzrad



Spurkranzrad aus Stahl BS 970
Lauffläche sauber überdreht
Neigungswinkel 3°

- sehr hohe Tragkraft
- sehr abriebfest
- für hohe Temperaturen

Technische Details

ORDERNO (Artikel-nummer)	300 SSFK 50
WDWOF (Rad-Ø o. Spurkranz / mm)	300
WDWF (Rad-Ø m. Spurkranz / mm)	345
TRW (Laufflächenbreite / mm)	60
WW (Radbreite / mm)	80
LC (Tragkraft / kg)	5800
HW (Nabellänge / mm)	80
WB (Radlager)	Kugellager
BD (Bohrungsdurchmesser / mm)	50