

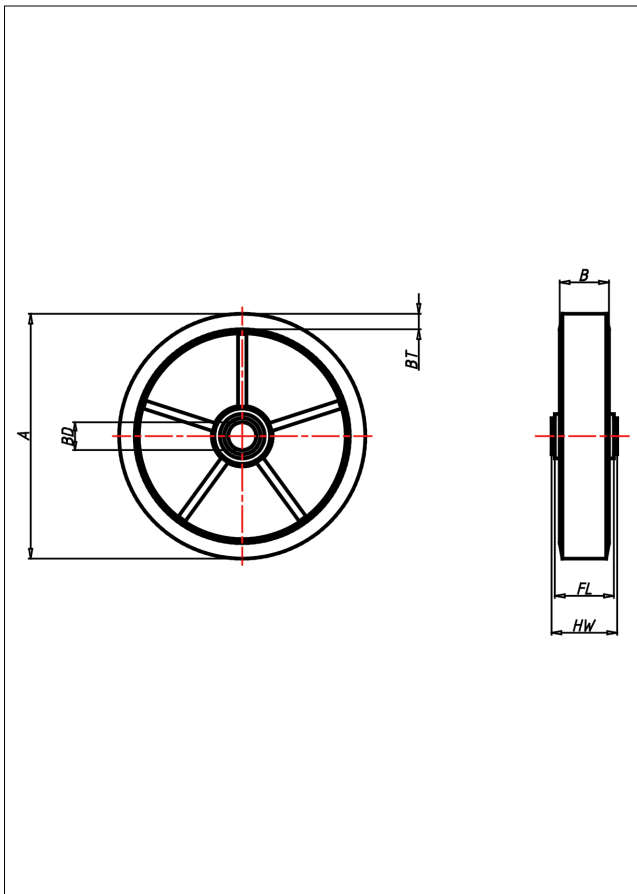

Z/SU Rad



Z/SU



Z

Radkörper aus Gusseisen lackiert
Laufbelag aus Guss-Polyurethan 95:3 Shore A

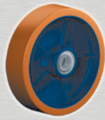

- geräuscharmer Lauf
- geringer Rollwiderstand
- abrieb- und reißfest
- hohe Stoßfestigkeit
- sehr beständig gegen viele aggressive Medien

Technische Details

ORDERNO (Artikel-nummer)	303 SUTM 31
WDAB (Rad-Ø A x Breite B / mm)	300x76
LC (Tragkraft / kg)	3000
BT (Reifenstärke / mm)	17
HW (Nabellänge / mm)	92
FL (Einbaulänge / mm)	92
WB (Radlager)	Schräggrollen-lager abgedichtet
BD (Bohrungsdurchmesser / mm)	31.8