

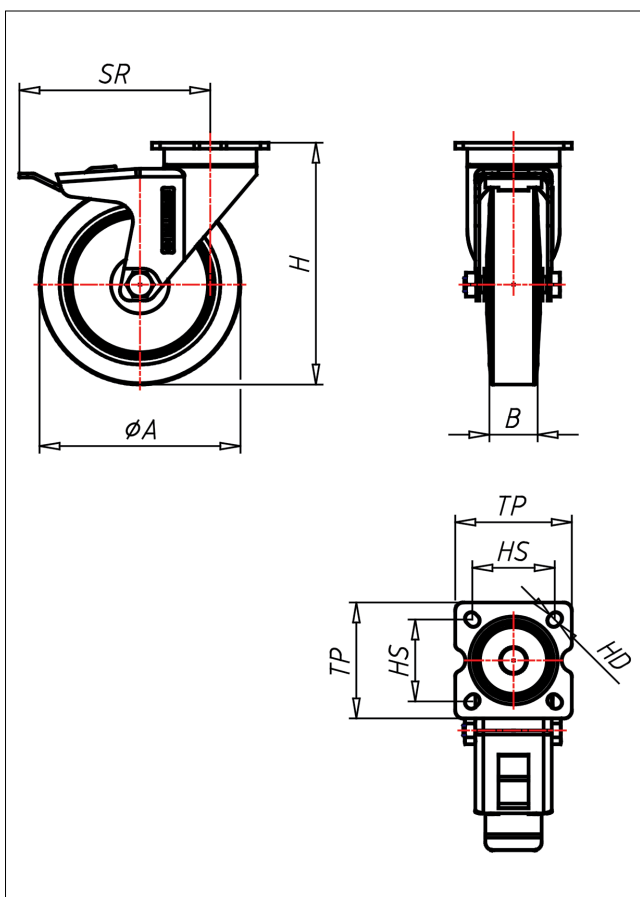

316 PT-GK/G/GL/GKL

Lenkrolle mit Totalfeststeller



315P-G



LENKROLLE	LENKROLLE MIT TOTALFESTSTELLER	BOCKROLLE										
<ul style="list-style-type: none"> • spurfrei • geräuscharmer Lauf • großer Fahrkomfort • beständig gegen verdünnte Säuren <p>Thermoplastisches Elastomer Felge Polyamid 6 → Seite 268</p>	<p>zweifaches Kugellager Ø 46 mm - vernietet, Staubschutzring, Radachse verschraubt - gesichert, verzinkt - chromatiert</p> <p>→ Seite</p>	<p>AUSWAHLHILFE:</p> <table border="0"> <tr> <td>leicht lenkend</td> <td><input checked="" type="checkbox"/></td> </tr> <tr> <td>verschleißarm</td> <td><input checked="" type="checkbox"/></td> </tr> <tr> <td>stoßfest</td> <td><input checked="" type="checkbox"/></td> </tr> <tr> <td>bodenschonend</td> <td><input checked="" type="checkbox"/></td> </tr> <tr> <td>witterungsbeständig</td> <td><input checked="" type="checkbox"/></td> </tr> </table>	leicht lenkend	<input checked="" type="checkbox"/>	verschleißarm	<input checked="" type="checkbox"/>	stoßfest	<input checked="" type="checkbox"/>	bodenschonend	<input checked="" type="checkbox"/>	witterungsbeständig	<input checked="" type="checkbox"/>
leicht lenkend	<input checked="" type="checkbox"/>											
verschleißarm	<input checked="" type="checkbox"/>											
stoßfest	<input checked="" type="checkbox"/>											
bodenschonend	<input checked="" type="checkbox"/>											
witterungsbeständig	<input checked="" type="checkbox"/>											

Technische Details

ORDERNO (Artikel-nummer)	316 PT 75 GKL
WDAB (Rad-Ø A x Breite B / mm)	75x25
LC (Tragkraft / kg)	60
H (Bauhöhe H / mm)	97
TP (Plattengröße / mm)	58x58
HS (Lochabstand / mm)	40x40/42x42
HD (Loch-Ø / mm)	6.2
SR (Schwenkradius / mm)	83
WB (Radlager)	Kugellager