

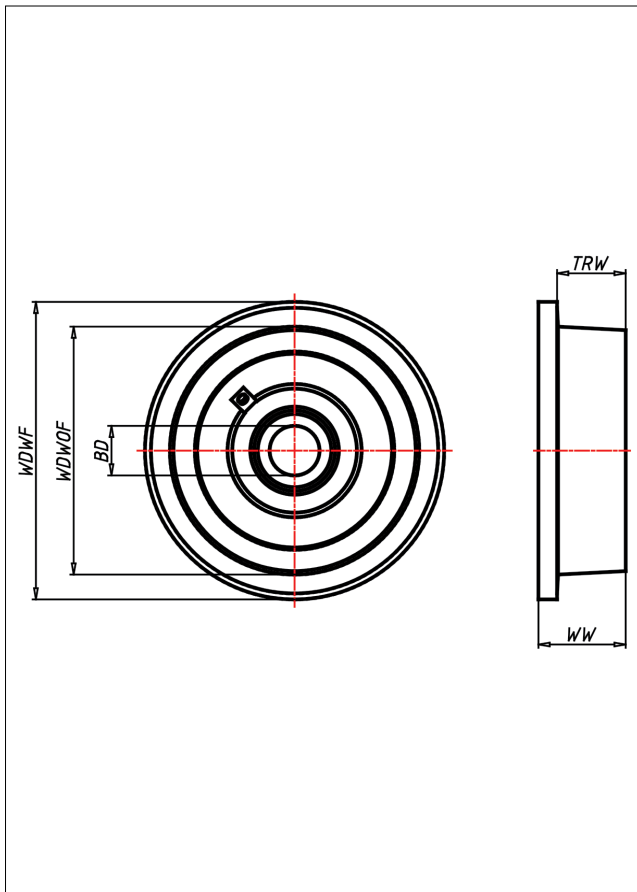

# SSF Spurkranzrad

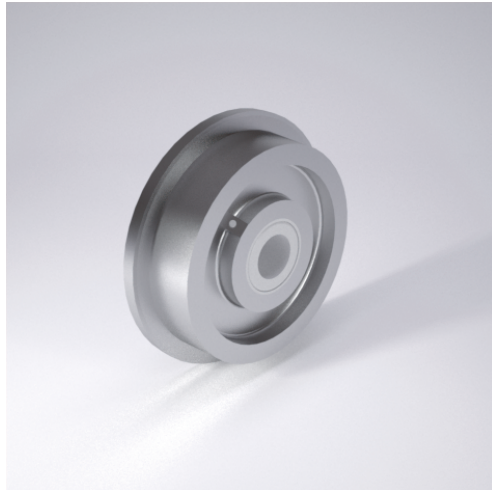

## SSF Spurkranzrad



Spurkranzrad aus Stahl BS 970  
Lauffläche sauber überdreht  
Neigungswinkel 3°

- sehr hohe Tragkraft
- sehr abriebfest
- für hohe Temperaturen

## Technische Details

ORDERNO (Artikel-nummer)	350 SSF-50
WDWOF (Rad-Ø o. Spurkranz / mm)	350
WDWF (Rad-Ø m. Spurkranz / mm)	395
TRW (Laufflächenbreite / mm)	60
WW (Radbreite / mm)	80
LC (Tragkraft / kg)	11700
HW (Nabellänge / mm)	80
WB (Radlager)	Bohrung mit Keilnut
BD (Bohrungsdurchmesser / mm)	50 H7