

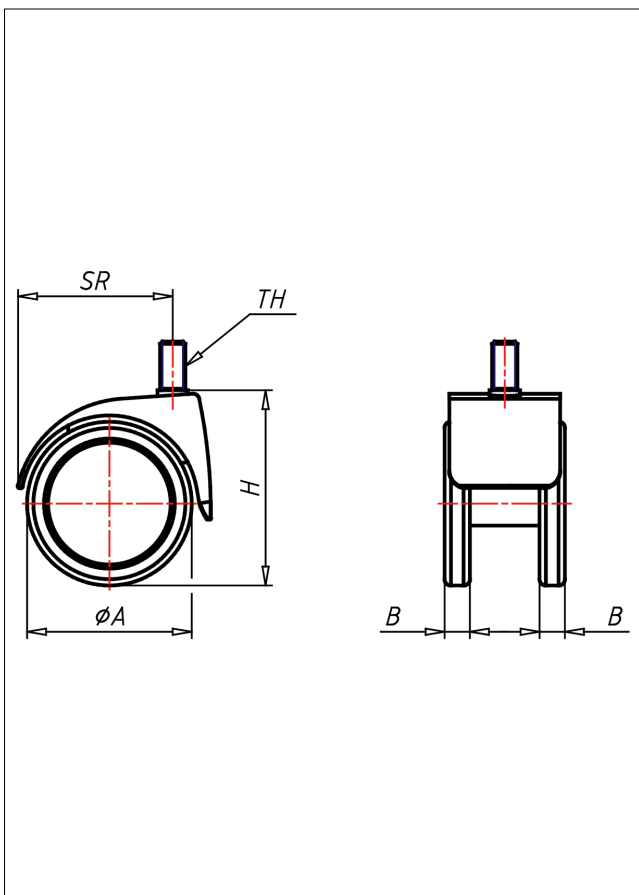

# 530 M8/M10/M12 PEL

Lenkrolle



530-PEL



+60 °C  
-20 °C  
max.  
60 kg



schwarzes Gehäuse aus Polyamid 6  
Schwenklager mit kombiniertem  
Gleit-Kugellager  
schwarzes Polyamid Vollrad  
elektrisch leitfähig  
Radfeststeller glasfaserverstärkt  
Radachse vernietet

## Technische Details

ORDERNO (Artikel-nummer)	530 M8 50 PEL
WDAB (Rad-Ø A x Breite B / mm)	52x8+8
LC (Tragkraft / kg)	40
H (Bauhöhe H / mm)	62
TH (Gewinde / mm)	M8x15
SR (Schwenkradius / mm)	46
WB (Radlager)	Polyamid-Gleitlager