

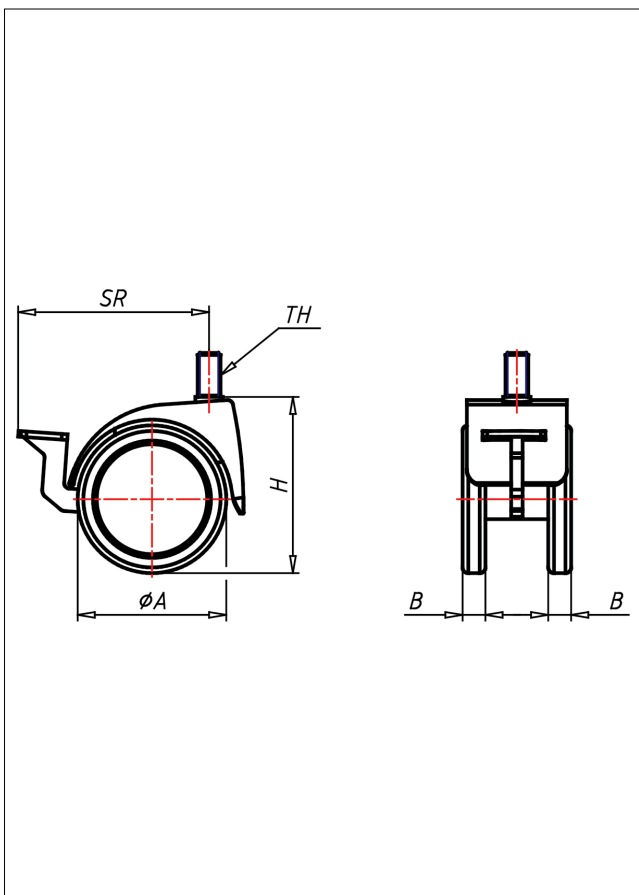

# 531 M8/M10/M12 PU

## Lenkrolle mit Radfeststeller

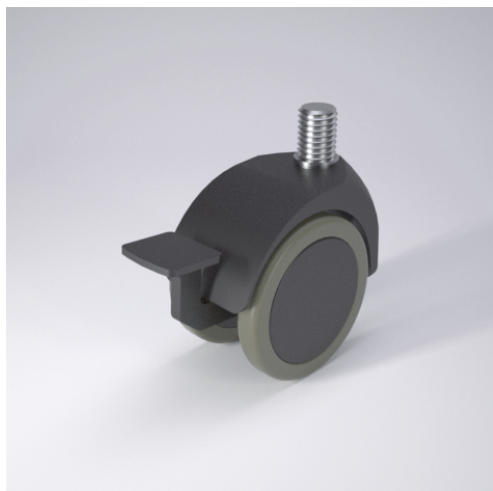

530-PU



schwarzes Gehäuse aus Polyamid 6  
Schwenklager mit kombiniertem  
Gleit-Kugellager  
Felge Polyamid schwarz  
elastischer PUR-Reifen - spurfrei  
Radfeststeller glasfaserverstärkt  
Radachse vernietet

### Technische Details

ORDERNO (Artikel-nummer)	531 M12 75 PU
WDAB (Rad-Ø A x Breite B / mm)	75x13+13
LC (Tragkraft / kg)	60
H (Bauhöhe H / mm)	93
TH (Gewinde / mm)	M12x15
SR (Schwenkradius / mm)	88
WB (Radlager)	Polyamid-Gleitlager