

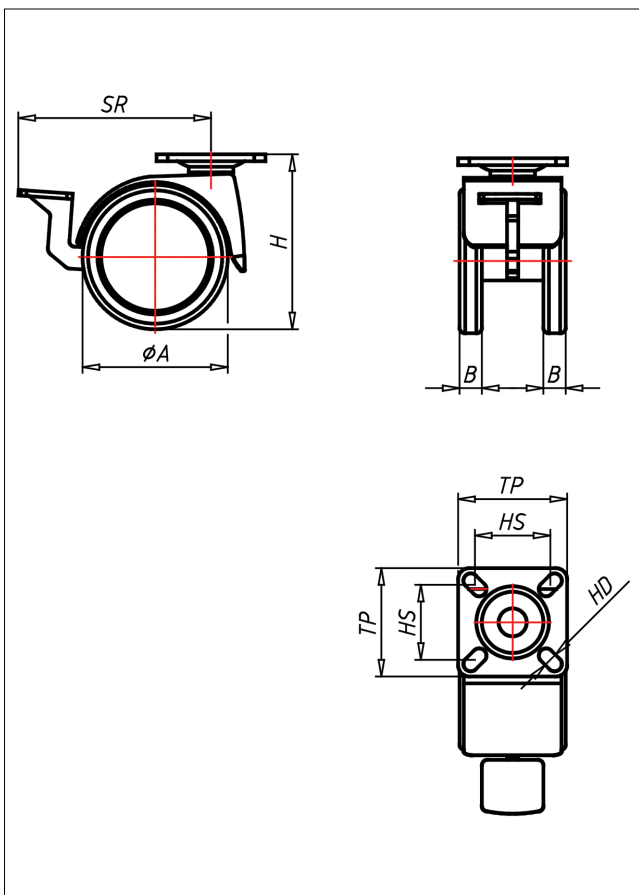

531 PT PU

Lenkrolle mit Radfeststeller

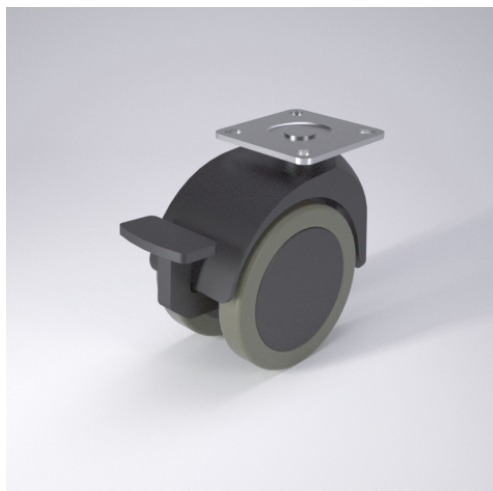

530-PU



schwarzes Gehäuse aus Polyamid 6
Schwenklager mit kombiniertem
Gleit-Kugellager
Felge Polyamid schwarz
elastischer PUR-Reifen - spurfrei
Radfeststeller glasfaserverstärkt
Radachse vernietet

Technische Details

ORDERNO (Artikel-nummer)	531 PT 50 PU
WDAB (Rad-Ø A x Breite B / mm)	52x8+8
LC (Tragkraft / kg)	40
H (Bauhöhe H / mm)	63
TP (Plattengröße / mm)	39x39
HS (Lochabstand / mm)	30x30/24x24
HD (Loch-Ø / mm)	5.2
SR (Schwenkradius / mm)	69
WB (Radlager)	Polyamid-Gleitlager