

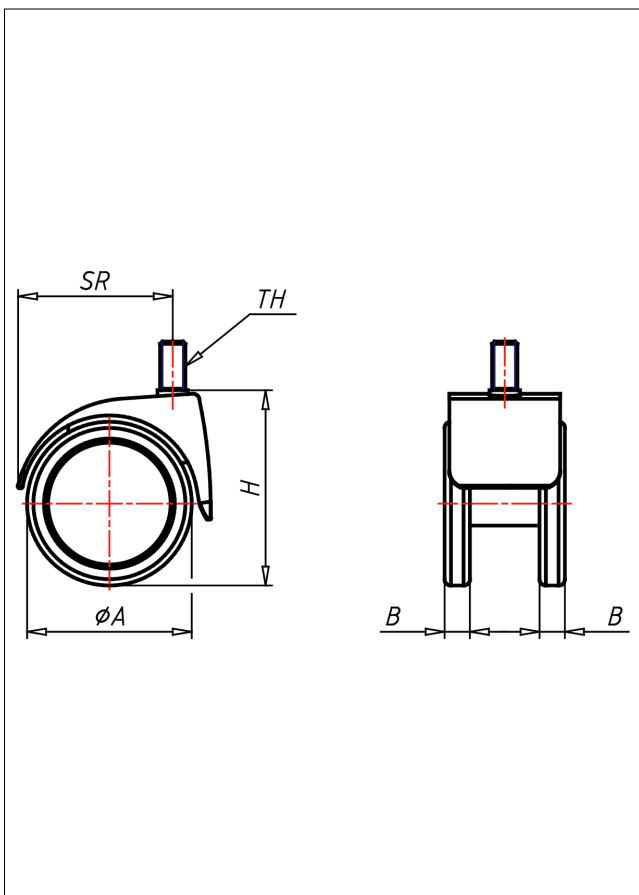

532 M8/M10/M12 PU

Stuhlrollen

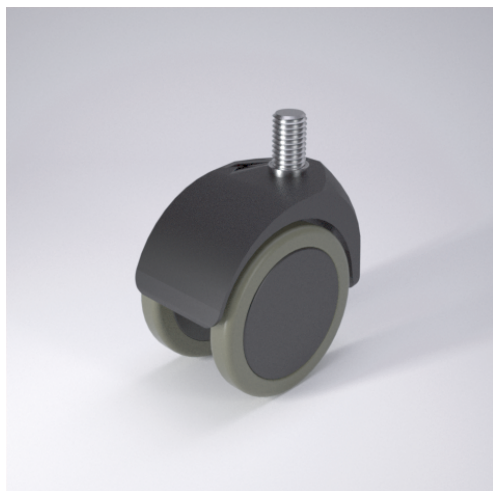

Stuhlrollen-PU Stuhlrollen



+60 °C
-20 °C
max.
40 kg



BÜROSTUHLROLLE mit lastabhängiger Radbremse nach EN 12529
Schwenklager mit kombiniertem Gleit-Kugellager
Felge Polyamid schwarz
elastischer PUR-Reifen - spurfrei
Radachse vernietet

Technische Details

ORDERNO (Artikel-nummer)	532 M8 50 PU
WDAB (Rad-Ø A x Breite B / mm)	52x8+8
LC (Tragkraft / kg)	40
H (Bauhöhe H / mm)	62
TH (Gewinde / mm)	M8x15
SR (Schwenkradius / mm)	46
WB (Radlager)	Polyamid-Gleitlager