

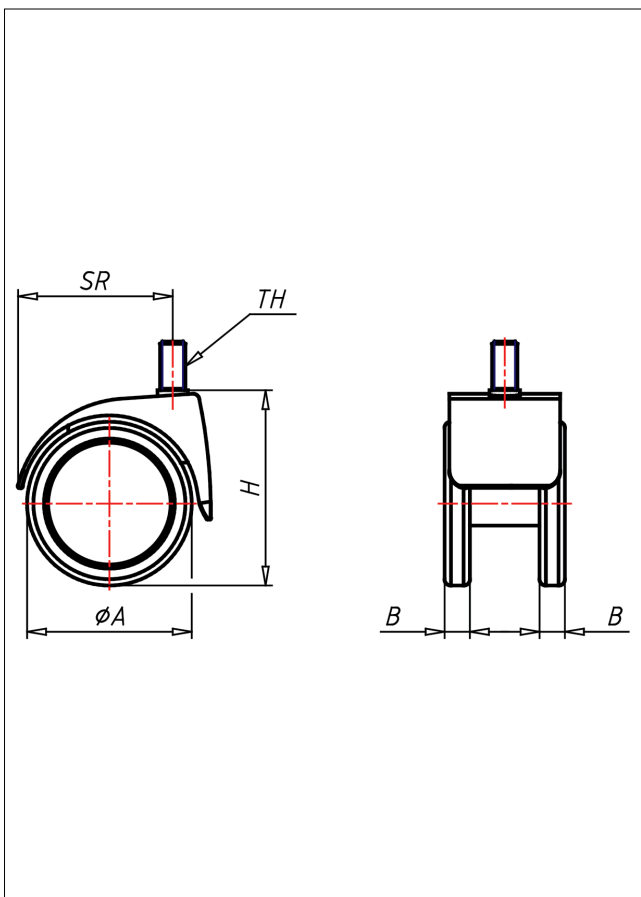

540 M8/M10/M12 PEL

Lenkrolle

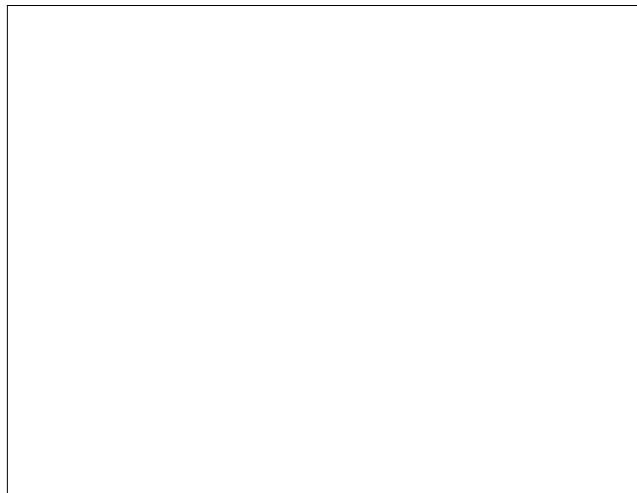

540-PEL



+60 °C max.
-20 °C 60 kg



Gehäuse: Zinkdruckguss - verchromt
Schwenklager mit kombiniertem
Gleit-Kugellager
schwarzes Polyamid Vollrad
elektrisch leitfähig
Radfeststeller glasfaserverstärkt
Radachse vernietet

Technische Details

ORDERNO (Artikel-nummer)	540 M12 50 PEL
WDAB (Rad-Ø A x Breite B / mm)	52x8+8
LC (Tragkraft / kg)	40
H (Bauhöhe H / mm)	62
TH (Gewinde / mm)	M12x15
SR (Schwenkradius / mm)	46
WB (Radlager)	Polyamid-Gleitlager