

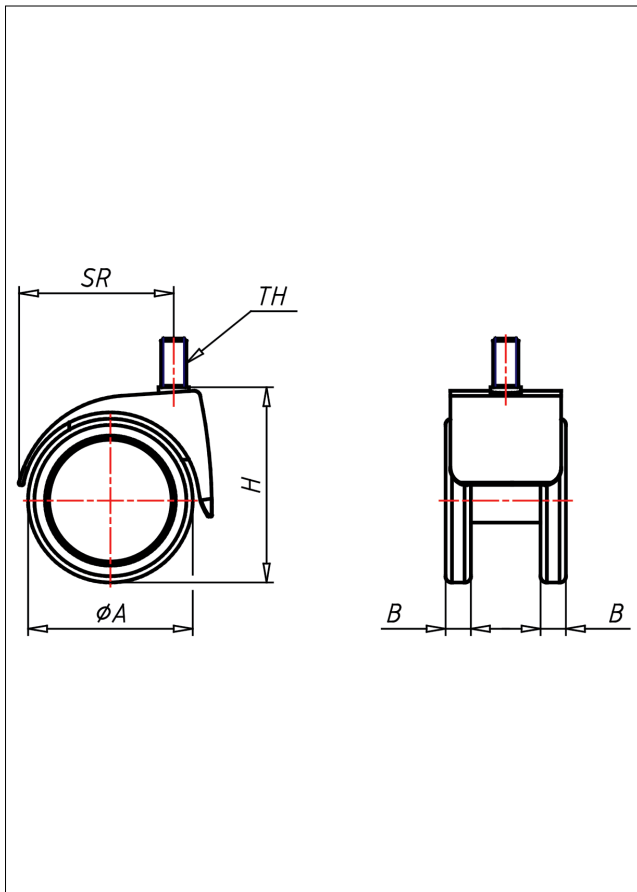

540 M8/M10/M12 PUEL

Lenkrolle

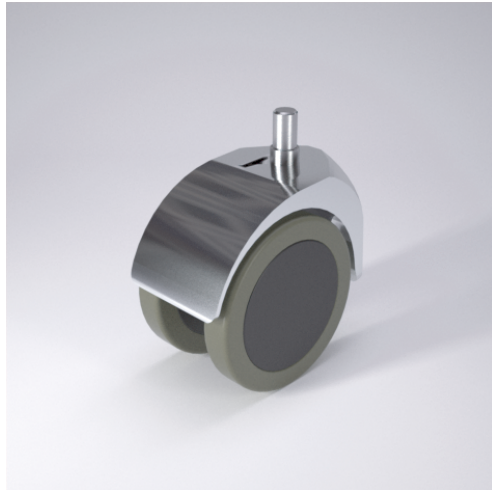

Technische Details

ORDERNO (Artikel-nummer)	540 M12 50 PUEL
WDAB (Rad-Ø A x Breite B / mm)	52x8+8
LC (Tragkraft / kg)	40
H (Bauhöhe H / mm)	62
TH (Gewinde / mm)	M12x15
SR (Schwenkradius / mm)	46
WB (Radlager)	Polyamid-Gleitlager