

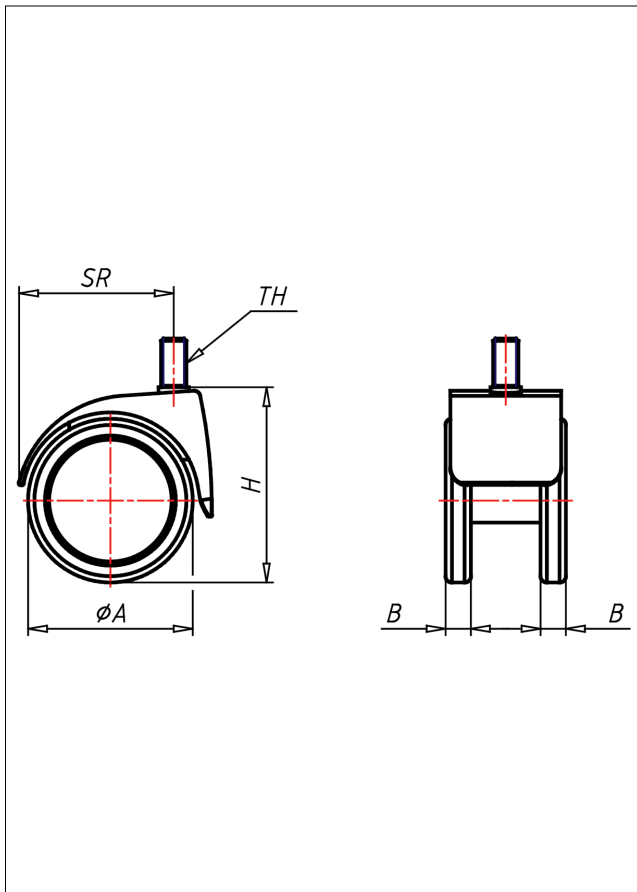

540 M8/M10/M12 PUEL

Lenkrolle

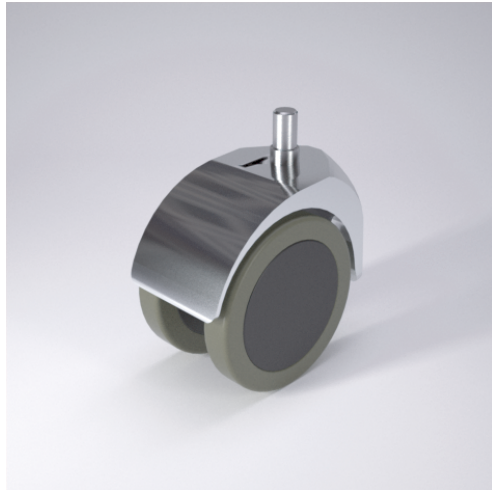

Technische Details

ORDERNO (Artikel-nummer)	540 M12 75 PUEL
WDAB (Rad-Ø A x Breite B / mm)	75x13+13
LC (Tragkraft / kg)	60
H (Bauhöhe H / mm)	93
TH (Gewinde / mm)	M12x15
SR (Schwenkradius / mm)	63.5
WB (Radlager)	Polyamid-Gleitlager