

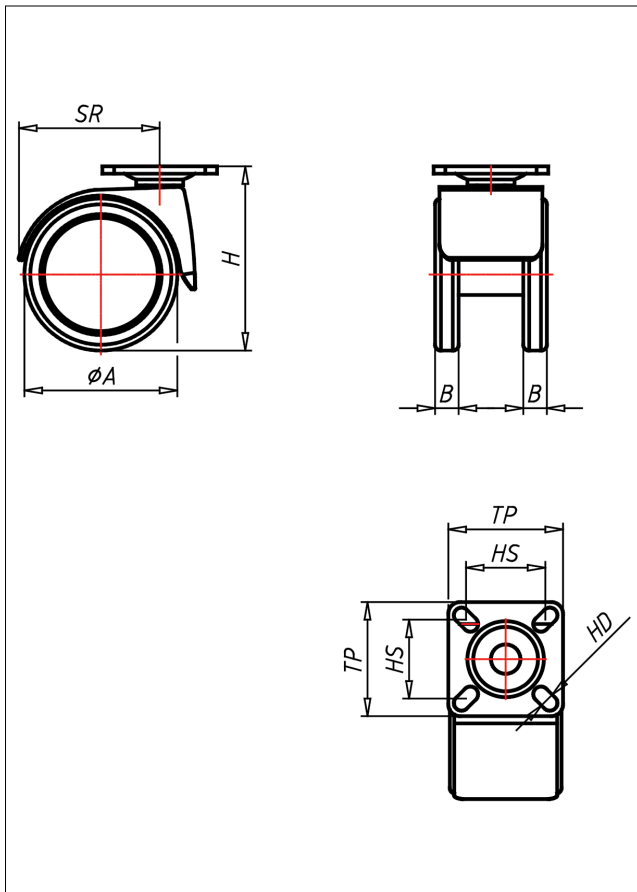

540 PT PU

Lenkrolle

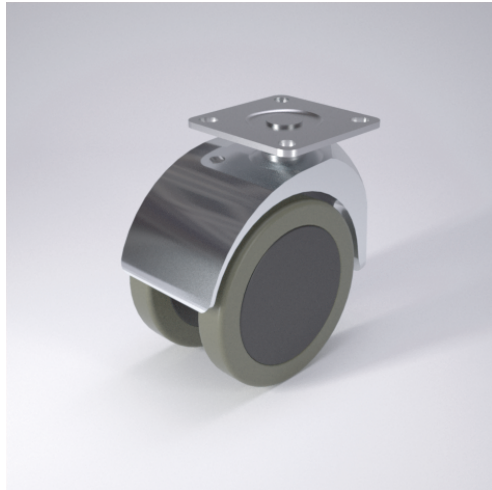

Technische Details

ORDERNO (Artikel-nummer)	540 PT 50 PU
WDAB (Rad- \varnothing A x Breite B / mm)	52x8+8
LC (Tragkraft / kg)	40
H (Bauhöhe H / mm)	63
TP (Plattengröße / mm)	39x39
HS (Lochabstand / mm)	30x30/24x24
HD (Loch- \varnothing / mm)	5.2
SR (Schwenkradius / mm)	46
WB (Radlager)	Polyamid-Gleitlager