

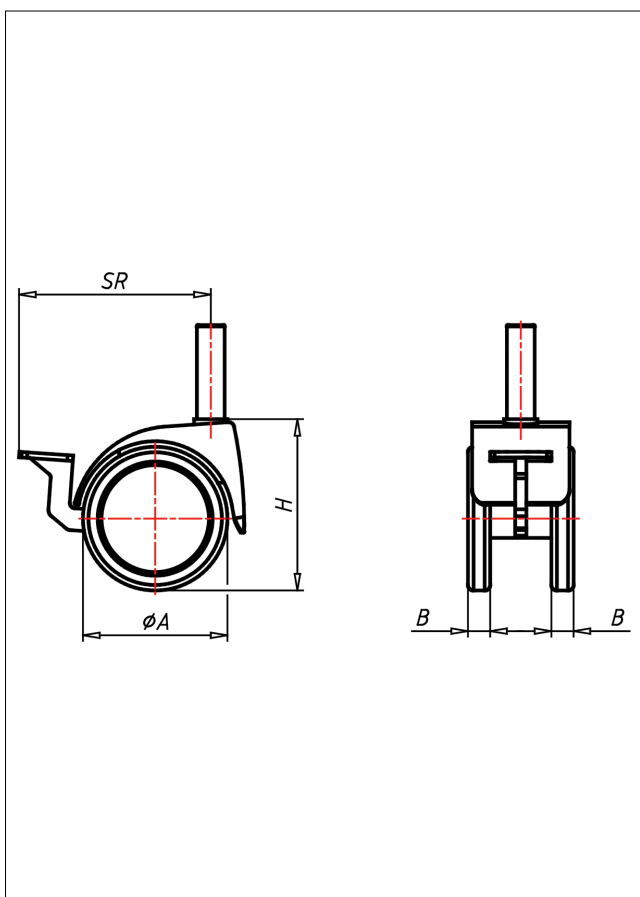

541 PU

Lenkrolle mit Radfeststeller

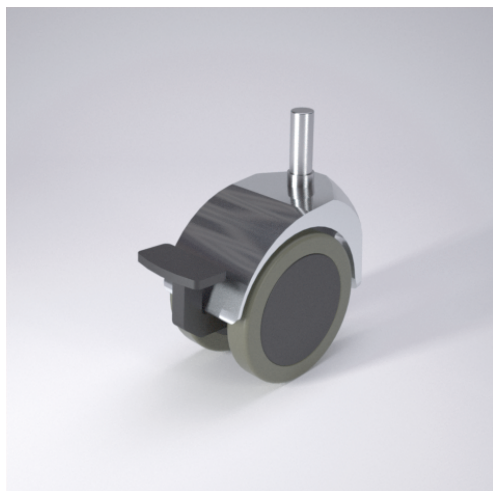

Technische Details

ORDERNO (Artikel-nummer)	541 10x34 75 PU
WDAB (Rad- ϕ A x Breite B / mm)	75x13+13
LC (Tragkraft / kg)	60
H (Bauhöhe H / mm)	93
BOLT (Stift / mm)	10x34
SR (Schwenkradius / mm)	88
WB (Radlager)	Polyamid-Gleitlager