

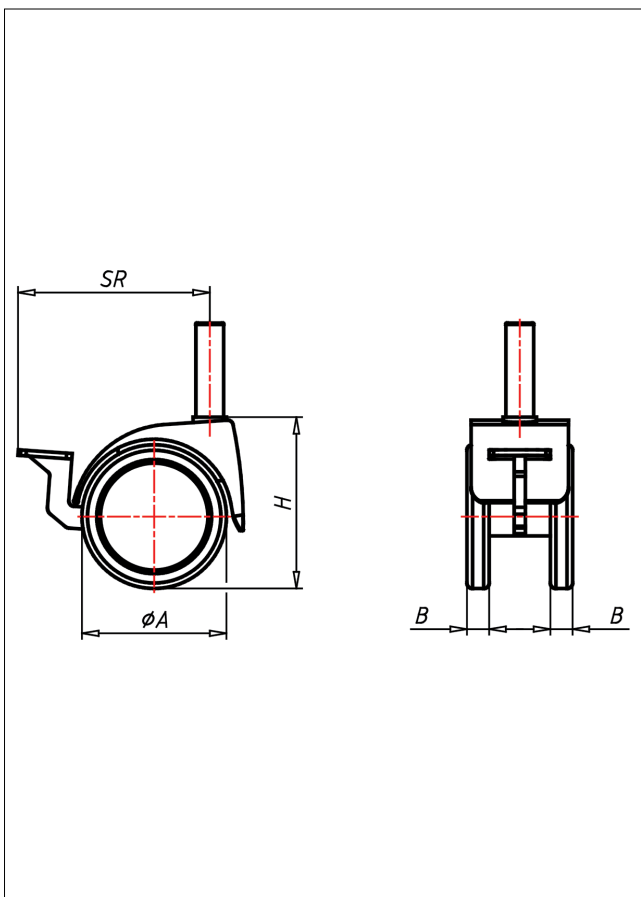

541 PUEL

Lenkrolle mit Radfeststeller

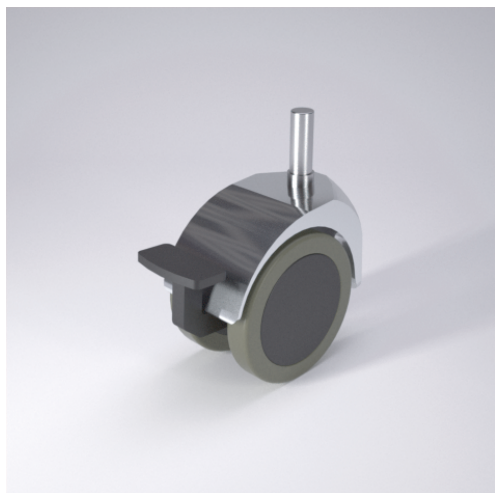

Technische Details

ORDERNO (Artikel-nummer)	541 11x22 50 PUEL
WDAB (Rad-ϕ A x Breite B / mm)	52x8+8
LC (Tragkraft / kg)	40
H (Bauhöhe H / mm)	62
BOLT (Stift / mm)	11x22
SR (Schwenkradius / mm)	69
WB (Radlager)	Polyamid-Gleitlager