

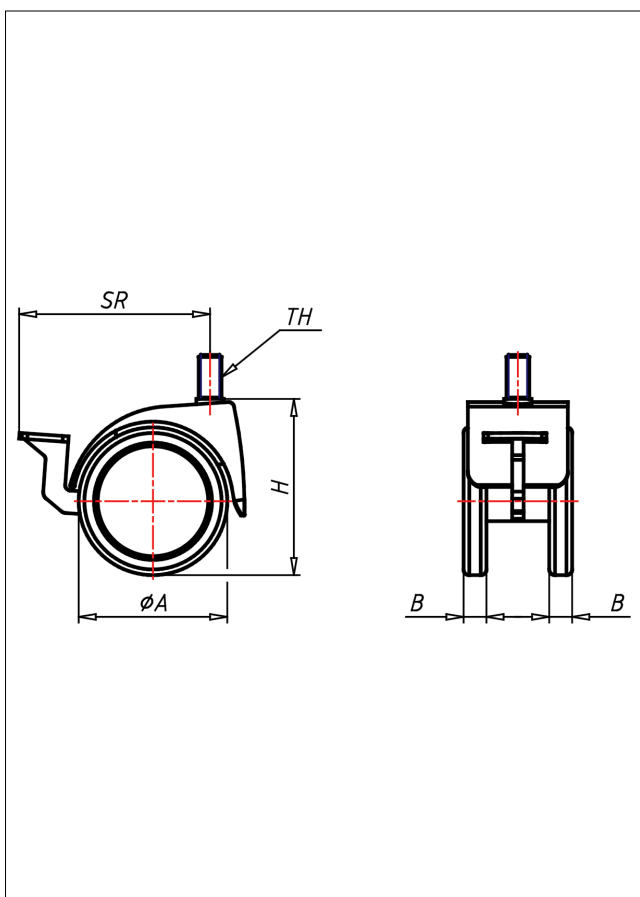

541 M8/M10/M12 PEL

Lenkrolle mit Radfeststeller



540-PEL



+60 °C max.
-20 °C 60 kg



Technische Details

ORDERNO (Artikel-nummer)	541 M8 50 PEL
WDAB (Rad-Ø A x Breite B / mm)	52x8+8
LC (Tragkraft / kg)	40
H (Bauhöhe H / mm)	62
TH (Gewinde / mm)	M8x15
SR (Schwenkradius / mm)	69
WB (Radlager)	Polyamid-Gleitlager