

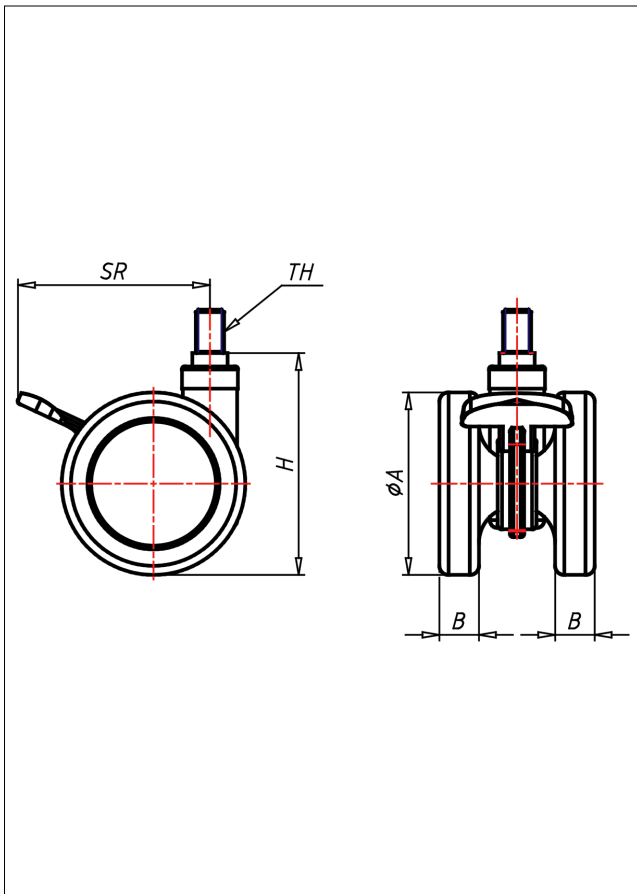

551 M10/M12 PUEL

Lenkrolle mit Totalfeststeller

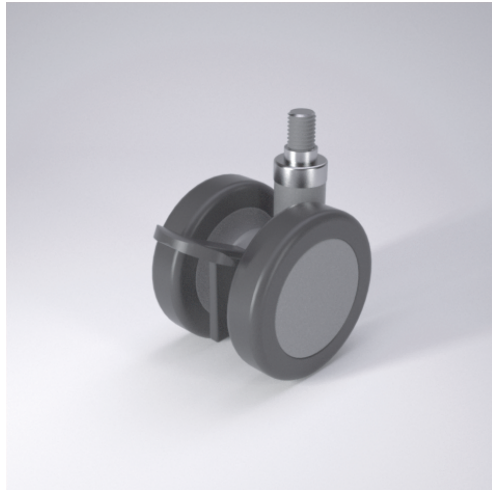

550-PUEL



+60 °C max.
-20 °C 100 kg



Gehäuse aus Polyamid 6 -
grau (RAL 7004), Schwenklager mit
kombiniertem Gleit-Kugellager
Folge Polyamid grau
elastischer PUR-Reifen grau -
spurfrei
elektrisch leitfähig
Feststeller glasfaserverstärkt

Technische Details

ORDERNO (Artikel-nummer)	551 M12 75 PUEL
WDAB (Rad-Ø A x Breite B / mm)	75x18+18
LC (Tragkraft / kg)	70
H (Bauhöhe H / mm)	90
TH (Gewinde / mm)	M12x15
SR (Schwenkradius / mm)	75
WB (Radlager)	Polyamid-Gleitlager