

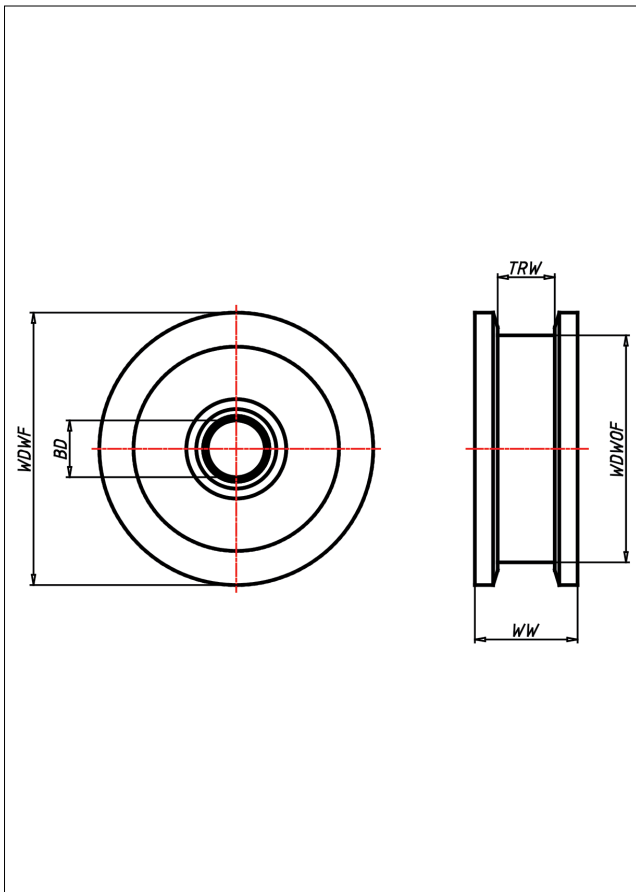

SDF

Doppel-Spurkranzrad



SDF Doppel-Spurkranzrad



Doppel-Spurkranzrad aus Stahl BS 970
Lauffläche sauber überdreht

- sehr hohe Tragkraft
- sehr abriebfest
- für hohe Temperaturen

Technische Details

ORDERNO (Artikel-nummer)	600 SDFTM 150
WDWOF (Rad-Ø o. Spurkranz / mm)	600
WDWF (Rad-Ø m. Spurkranz / mm)	660
TRW (Laufflächenbreite / mm)	100
WW (Radbreite / mm)	150
LC (Tragkraft / kg)	33600
HW (Nabellänge / mm)	150
WB (Radlager)	Schräggrollenlager
BD (Bohrungsdurchmesser / mm)	150