

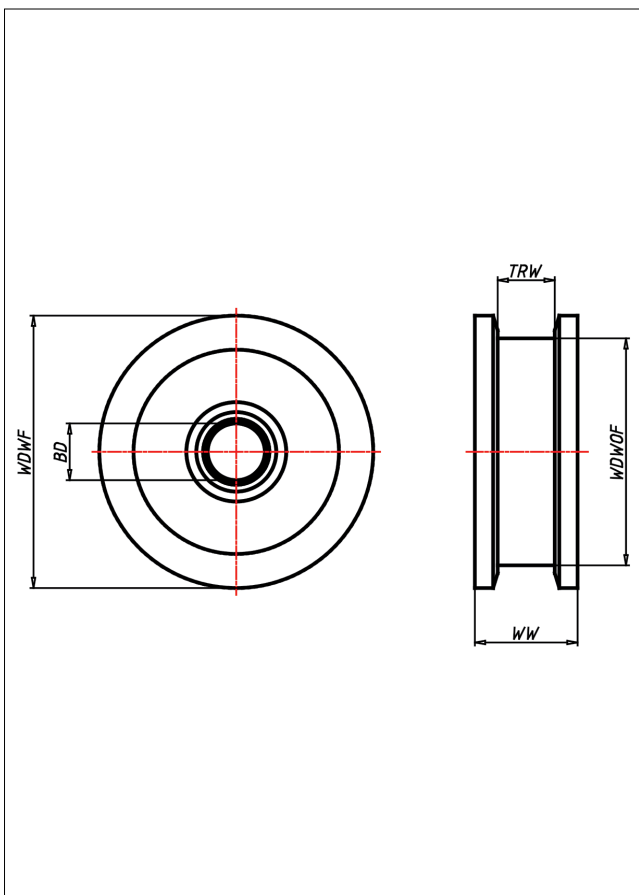

SDF

Doppel-Spurkranzrad



SDF Doppel-Spurkranzrad

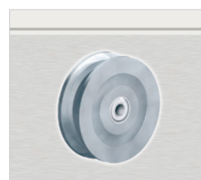

Doppel-Spurkranzrad aus Stahl BS 970
Lauffläche sauber überdreht

- sehr hohe Tragkraft
- sehr abriebfest
- für hohe Temperaturen

Technische Details

ORDERNO (Artikel-nummer)	75 SDFTM 25
WDWOF (Rad-Ø o. Spurkranz / mm)	75
WDWF (Rad-Ø m. Spurkranz / mm)	100
TRW (Laufflächenbreite / mm)	35
WW (Radbreite / mm)	60
LC (Tragkraft / kg)	1400
HW (Nabellänge / mm)	60
WB (Radlager)	Schräggrollenlager
BD (Bohrungsdurchmesser / mm)	25