

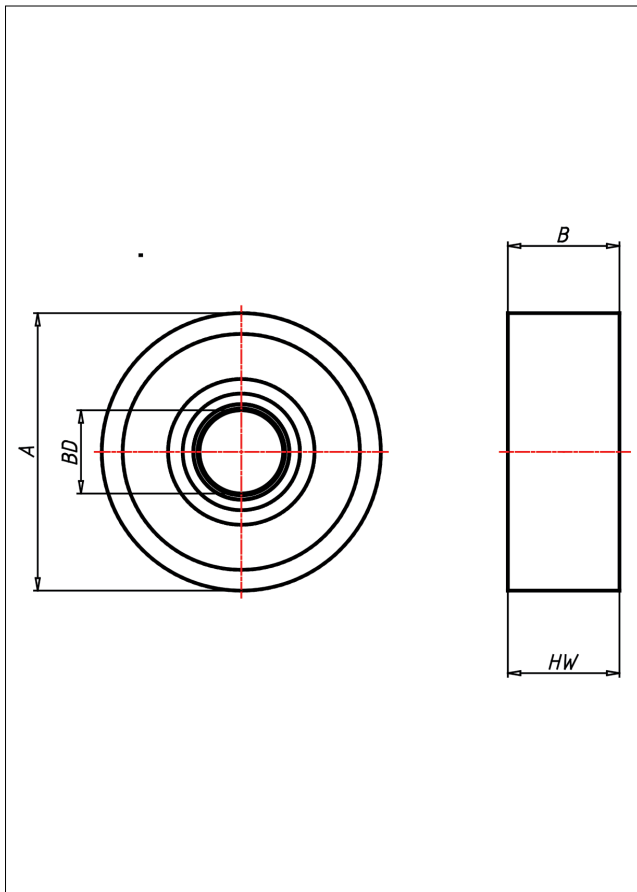

# SFT Schienenrad

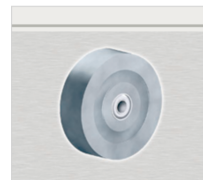

## SFT Schienenrad



Schienenrad aus Stahl BS 970  
Lauffläche sauber überdreht

- sehr hohe Tragkraft
- sehr abriebfest
- für hohe Temperaturen

## Technische Details

<b>ORDERNO (Artikel-nummer)</b>	75 SFTK 30
<b>WDAB (Rad-Ø A x Breite B / mm)</b>	75x60
<b>LC (Tragkraft / kg)</b>	2040
<b>HW (Nabellänge / mm)</b>	60
<b>WB (Radlager)</b>	Kugellager
<b>BD (Bohrungsdurchmesser / mm)</b>	30