

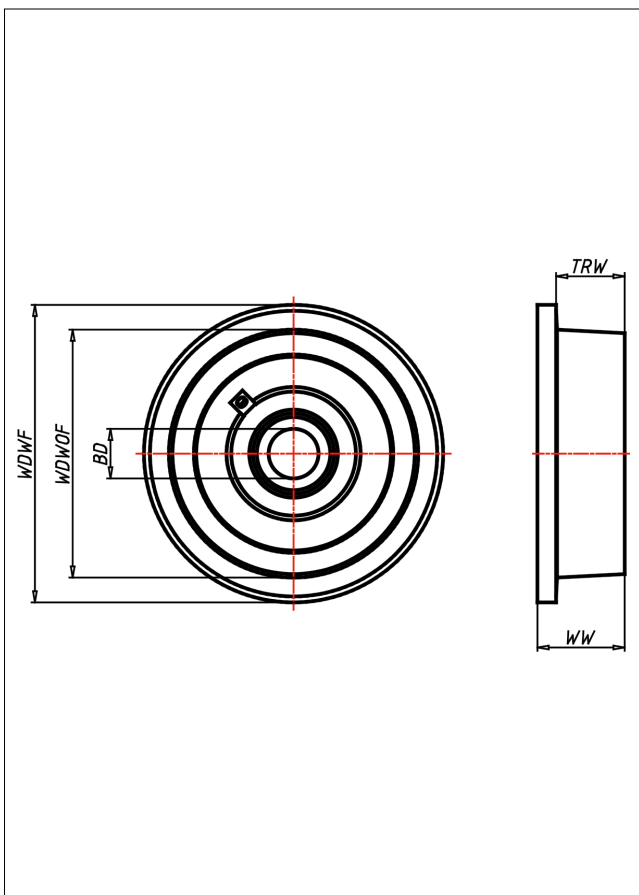

SSF Spurkranzrad

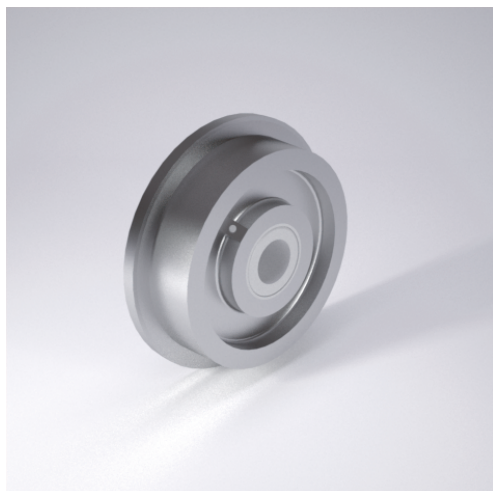

SSF Spurkranzrad



Spurkranzrad aus Stahl BS 970
Lauffläche sauber überdreht
Neigungswinkel 3°

- sehr hohe Tragkraft
- sehr abriebfest
- für hohe Temperaturen

Technische Details

ORDERNO (Artikel-nummer)	75 SSFTM 20
WDWOF (Rad-Ø o. Spurkranz / mm)	75
WDFW (Rad-Ø m. Spurkranz / mm)	100
TRW (Laufflächenbreite / mm)	25
WW (Radbreite / mm)	37
LC (Tragkraft / kg)	1000
HW (Nabellänge / mm)	37
WB (Radlager)	Schräggrollenlager
BD (Bohrungsdurchmesser / mm)	20