

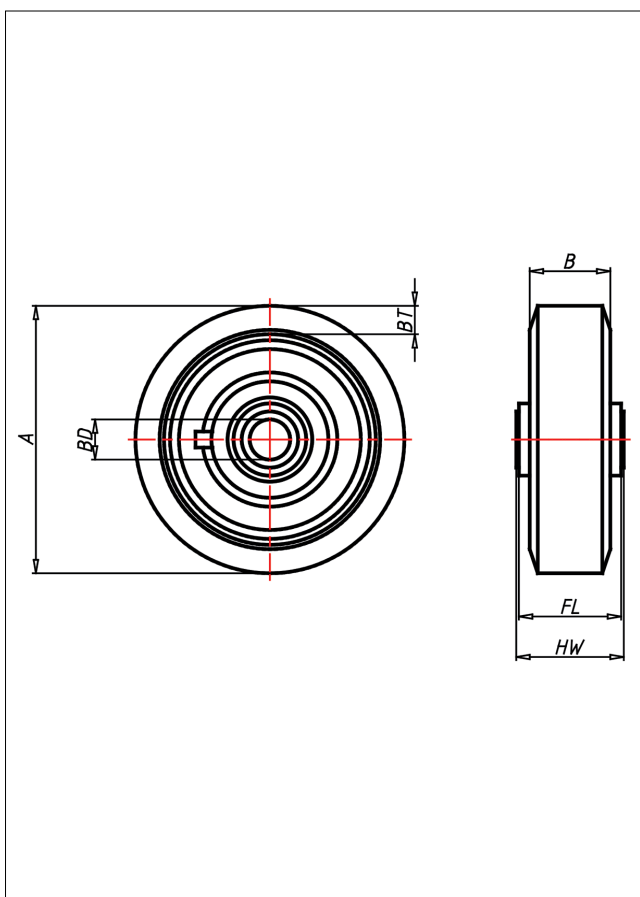

# A Rad

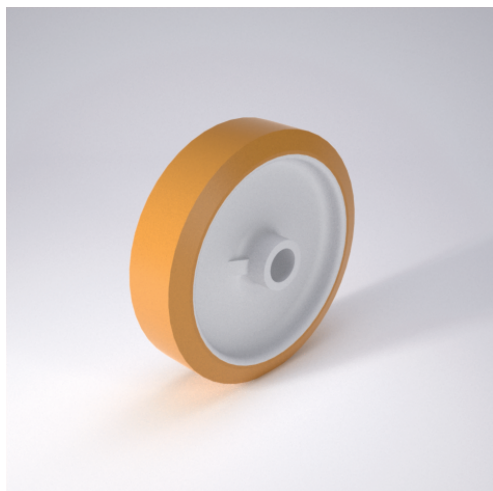

A



Radkörper aus Polyamid 6 - 1. Wahl  
Laufbelag aus Guss-Polyurethan, 95±3 Shore A

- geräuscharmer Lauf
- geringer Rollwiderstand
- abrieb- und reißfest
- hohe Stoßfestigkeit
- leichte Reinigung
- sehr beständig gegen viele aggressive Medien

## Technische Details

<b>ORDERNO (Artikel-nummer)</b>	80 A-10
<b>WDAB (Rad-Ø A x Breite B / mm)</b>	80x24
<b>LC (Tragkraft / kg)</b>	120
<b>BT (Reifenstärke / mm)</b>	10
<b>HW (Nabellänge / mm)</b>	28
<b>FL (Einbaulänge / mm)</b>	28
<b>WB (Radlager)</b>	Polyamid-Gleitlager
<b>BD (Bohrungsdurchmesser / mm)</b>	10