

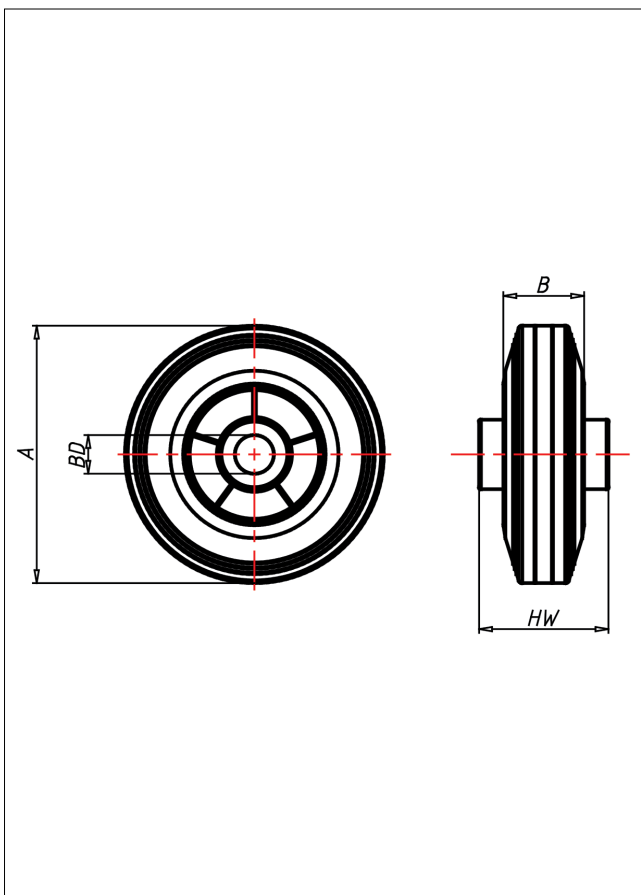

# DG Rad

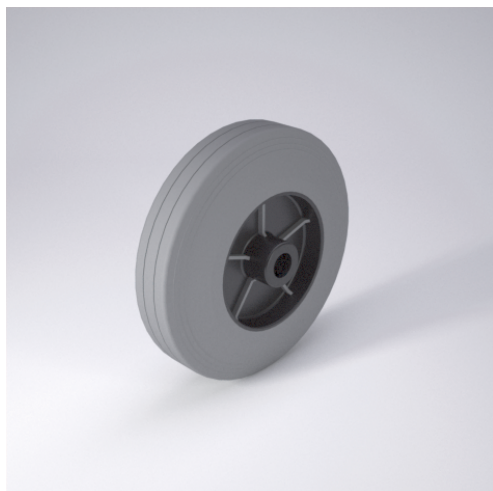

DG



+60 °C  
-20 °C max.  
kg 320 kg

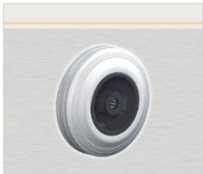

Radkörper aus hochwertigem schwarzen Kunststoff, Elastik-Vollgummireifen, grau, 75±5 Shore A

- spurfrei - bodenschonend
- ausgezeichneter Fahrkomfort
- sehr lauffähig
- geringer Rollwiderstand
- abriebfest

### Technische Details

<b>ORDERNO (Artikel-nummer)</b>	80 DG-12
<b>WDAB (Rad-Ø A x Breite B / mm)</b>	80x25
<b>LC (Tragkraft / kg)</b>	55
<b>HW (Nabellänge / mm)</b>	40
<b>FL (Einbaulänge / mm)</b>	40
<b>WB (Radlager)</b>	Polyamid-Gleitlager
<b>BD (Bohrungsdurchmesser / mm)</b>	12